

Tracing practice section with three rows of handwriting lines (top, middle dashed, bottom).

Row 1: Uppercase B tracing. Starts with a solid B showing stroke order (1, 2, 3). Followed by four dotted B's for tracing.

Row 2: Lowercase b tracing. Starts with a solid b showing stroke order (1, 2). Followed by four dotted b's for tracing.

Row 3: Mixed case Bb tracing. Starts with a solid Bb. Followed by three dotted Bb pairs for tracing.

Below the tracing rows are two additional empty handwriting lines for independent practice.

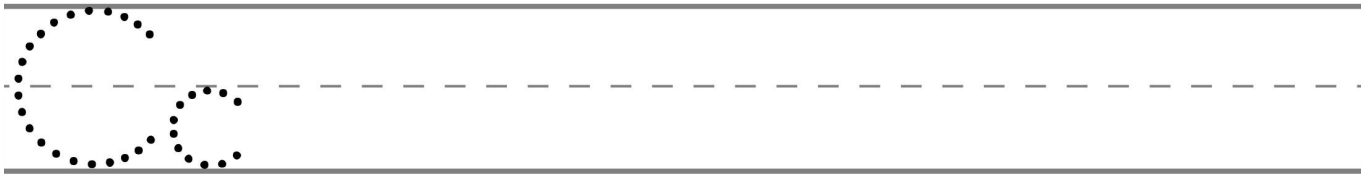
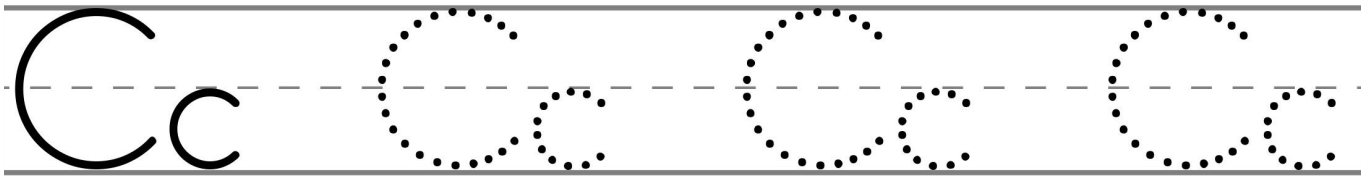
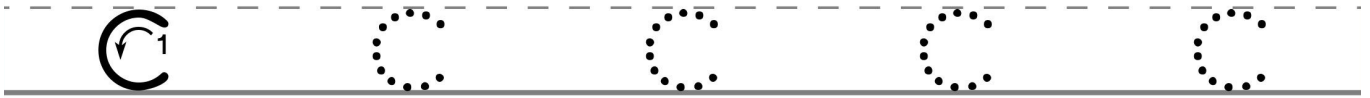
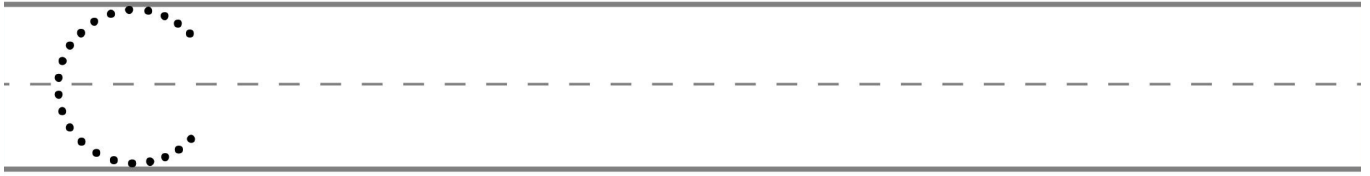
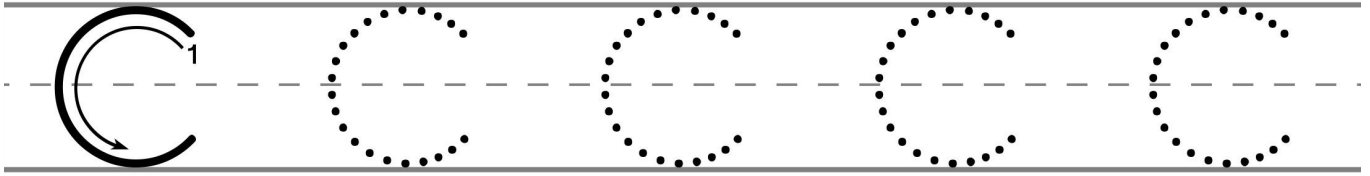
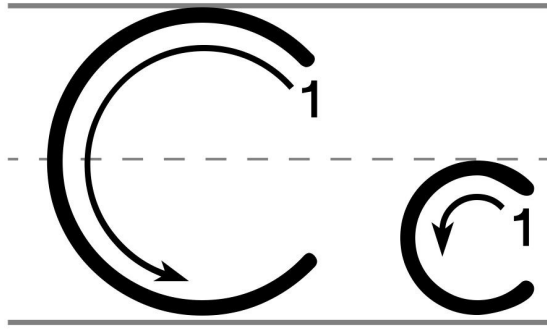

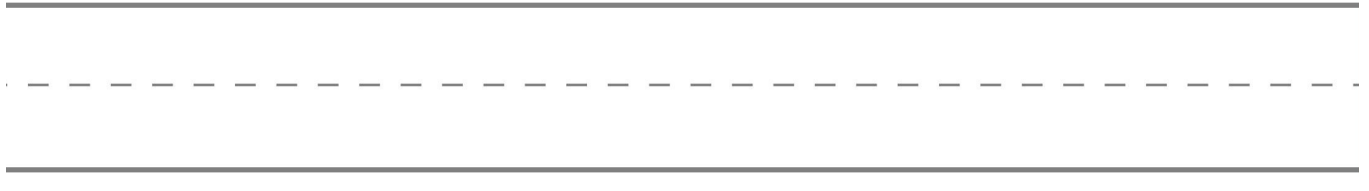
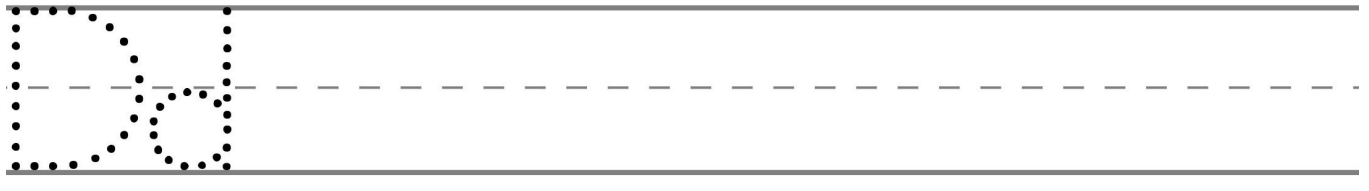
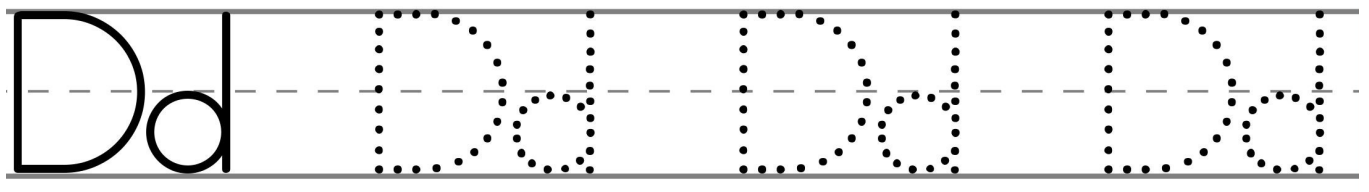
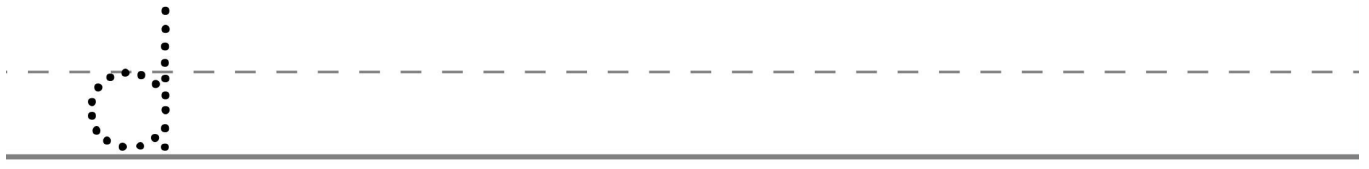
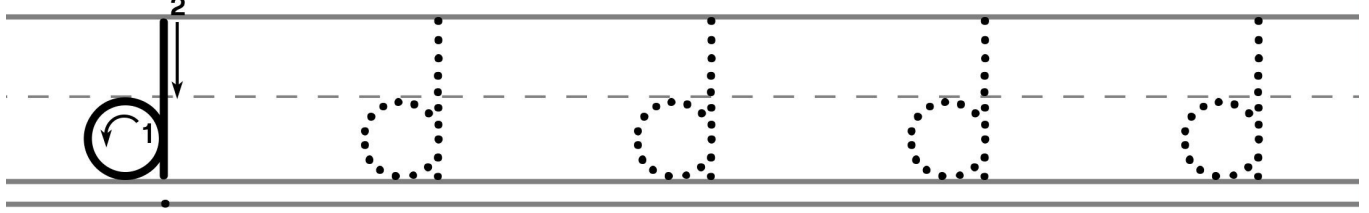
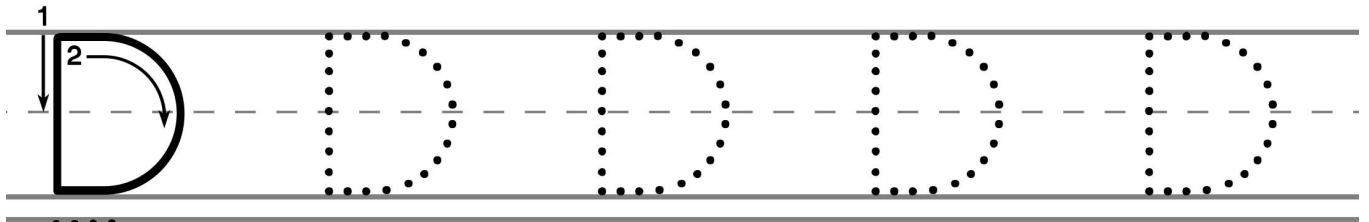
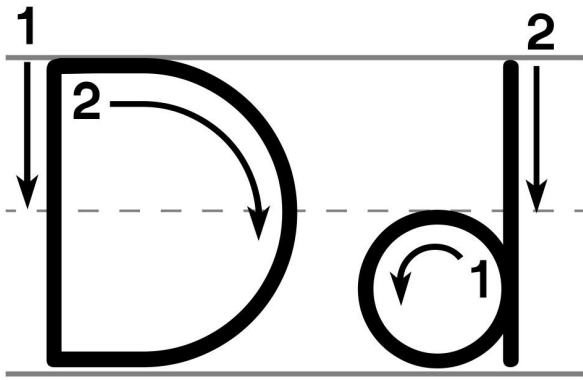

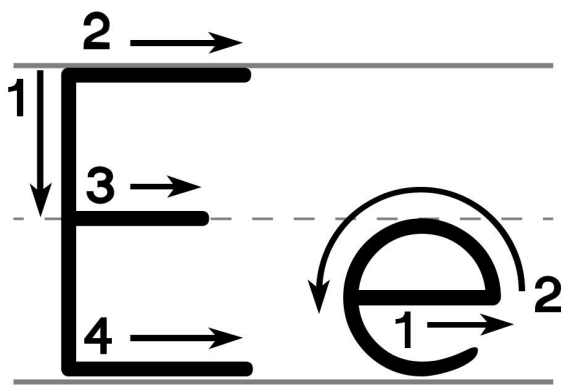

Tracing practice for uppercase E. The first row shows a solid uppercase E with stroke order arrows (1: vertical down, 2: top horizontal right, 3: middle horizontal right, 4: bottom horizontal right) followed by four dotted uppercase E's for tracing. The second row contains a single dotted uppercase E for tracing.

Tracing practice for lowercase e. The first row shows a solid lowercase e with stroke order arrows (1: counter-clockwise circle, 2: horizontal bar from center to right) followed by four dotted lowercase e's for tracing. The second row contains a single dotted lowercase e for tracing.

Tracing practice for mixed case. The first row shows a solid uppercase E and lowercase e, followed by three pairs of dotted uppercase E and lowercase e for tracing. The second row contains a dotted uppercase E and lowercase e for tracing.

Blank handwriting lines for independent practice of uppercase E and lowercase e.

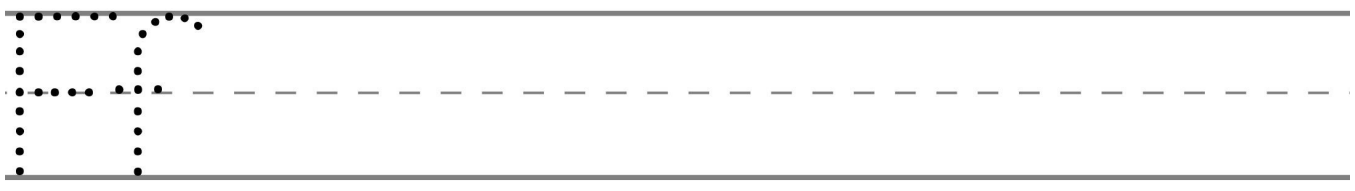
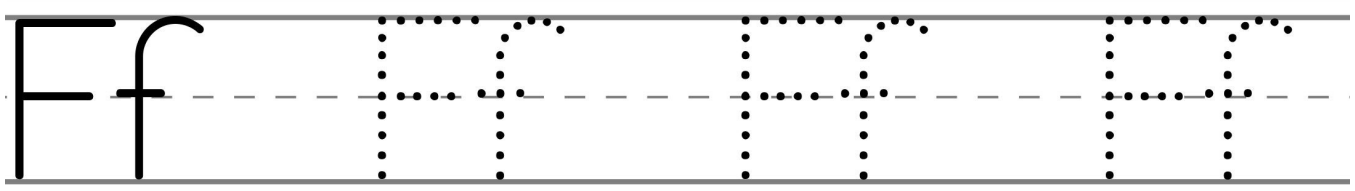
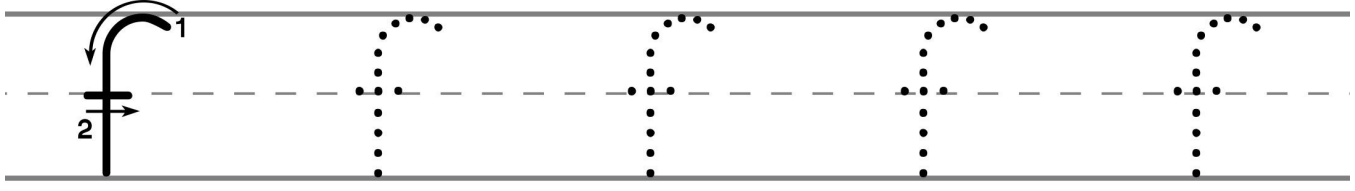
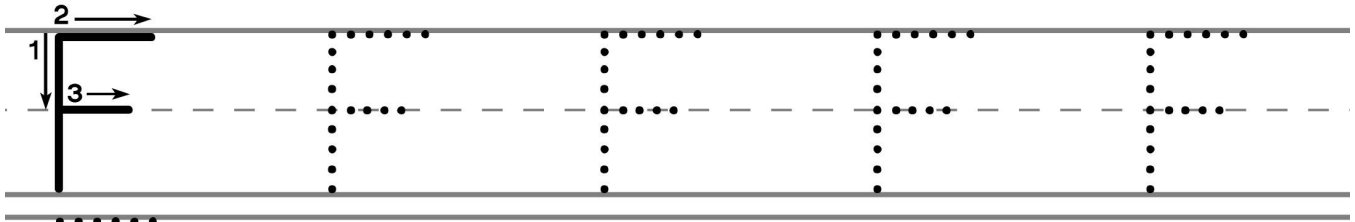
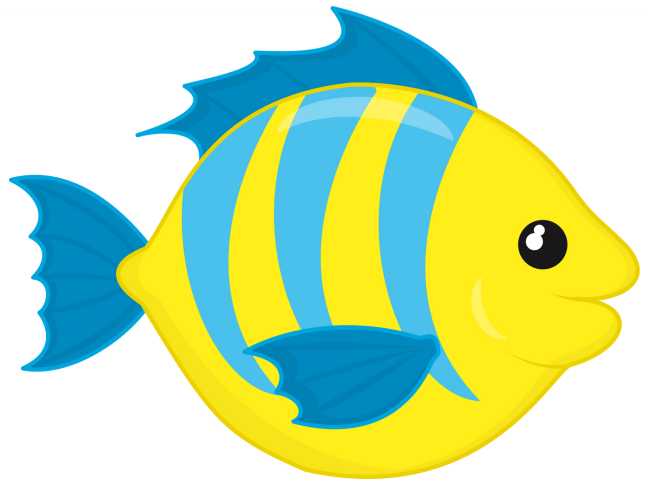
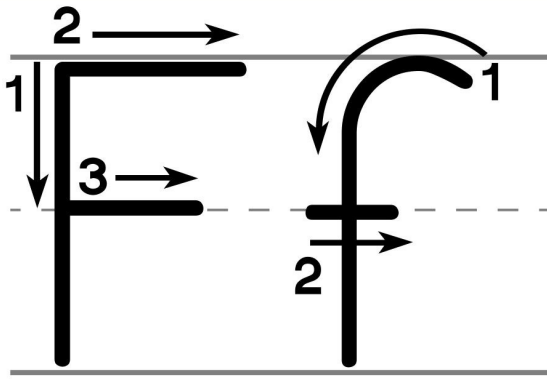

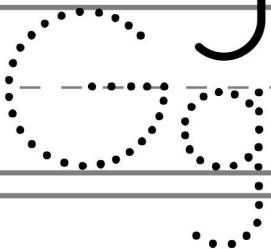
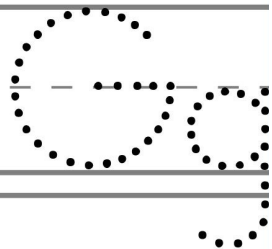
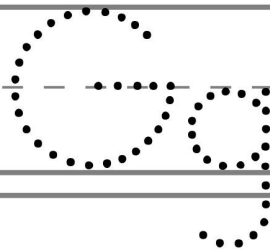
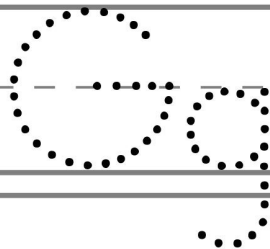
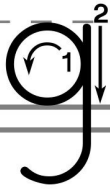
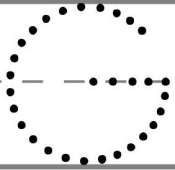
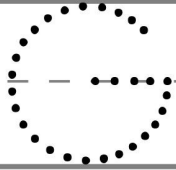
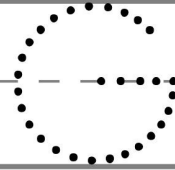
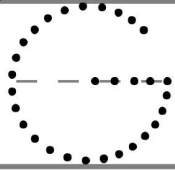
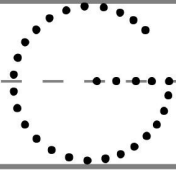
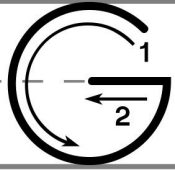
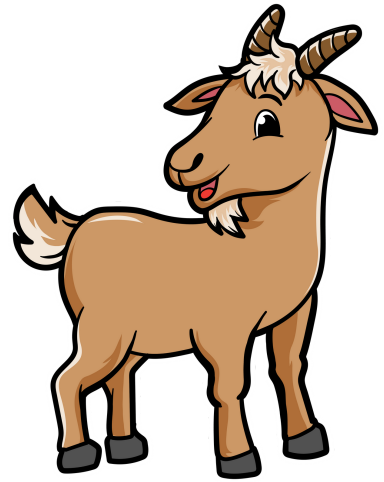
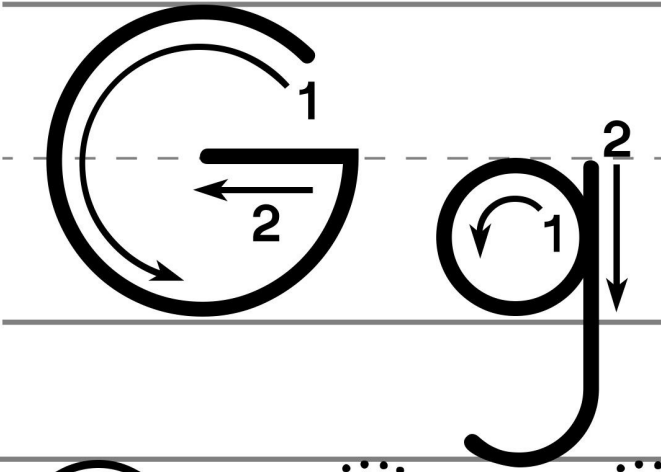

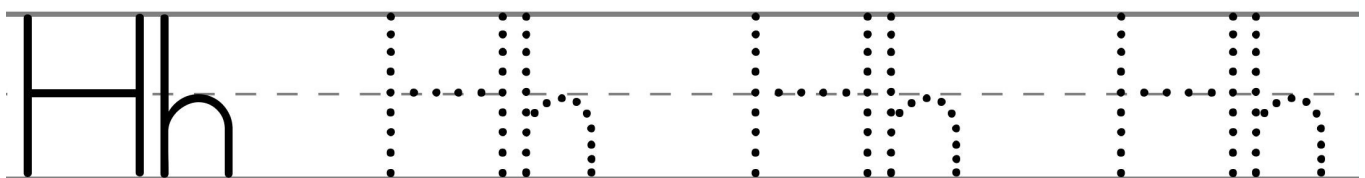
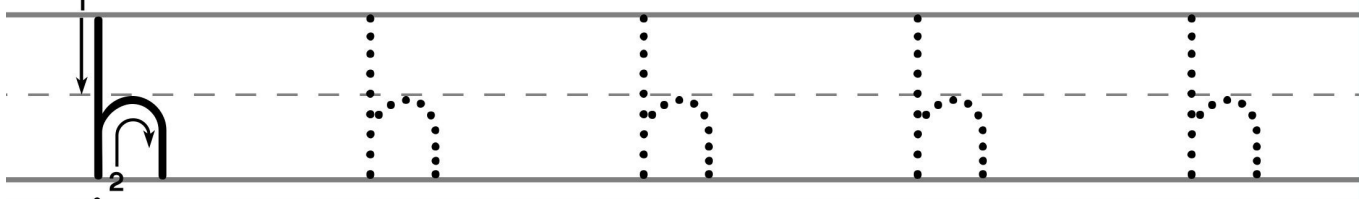
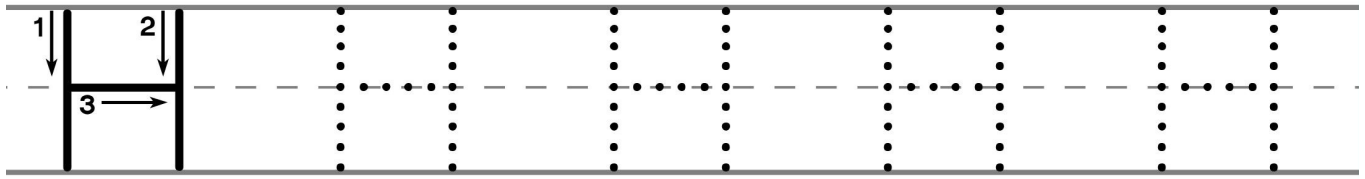
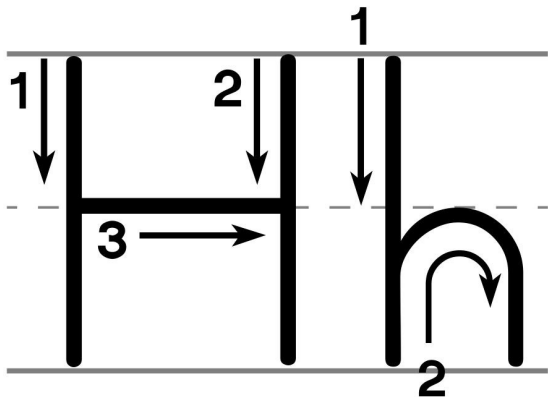



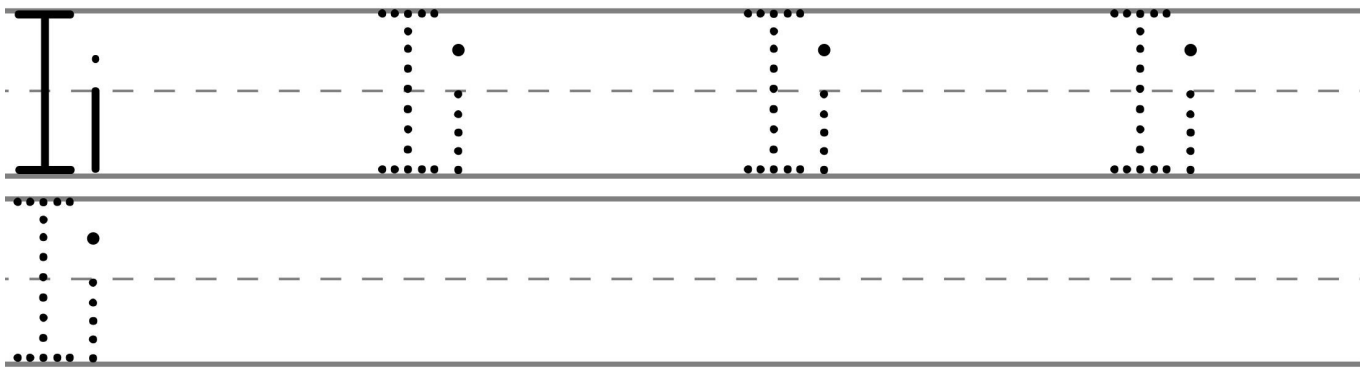
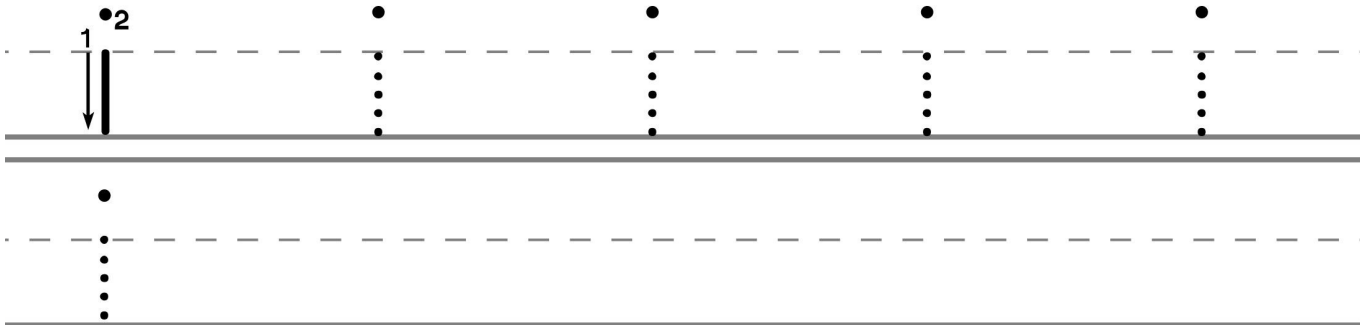
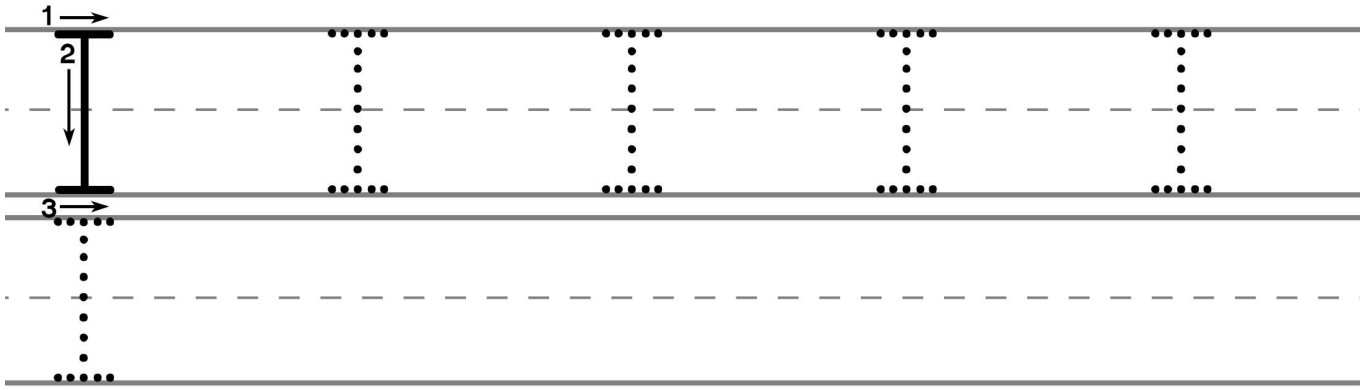
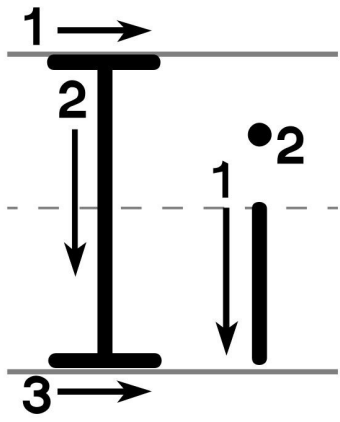

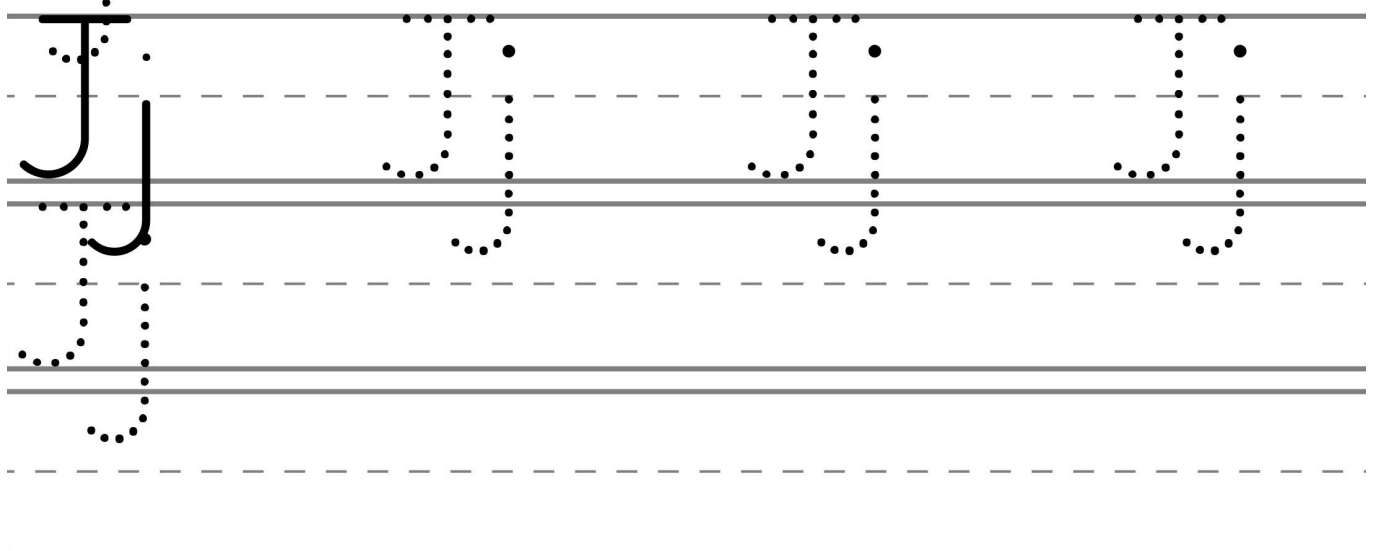
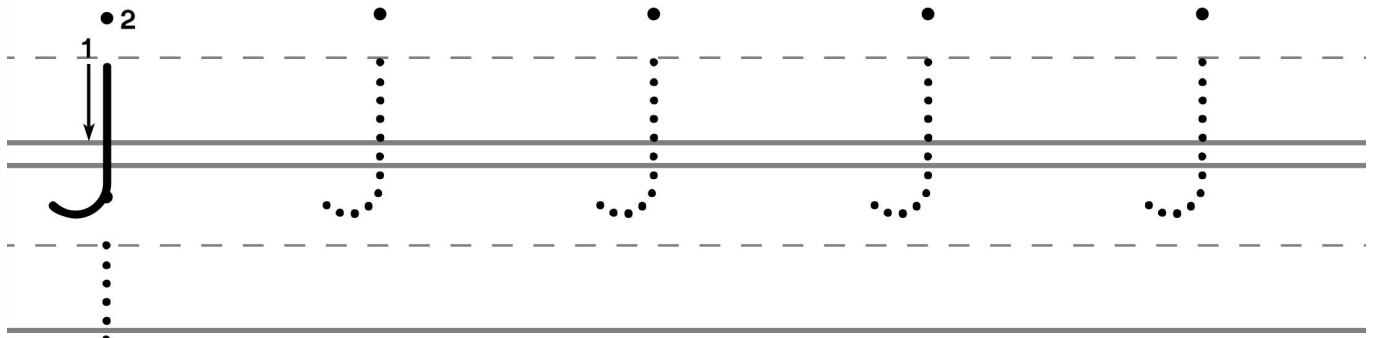
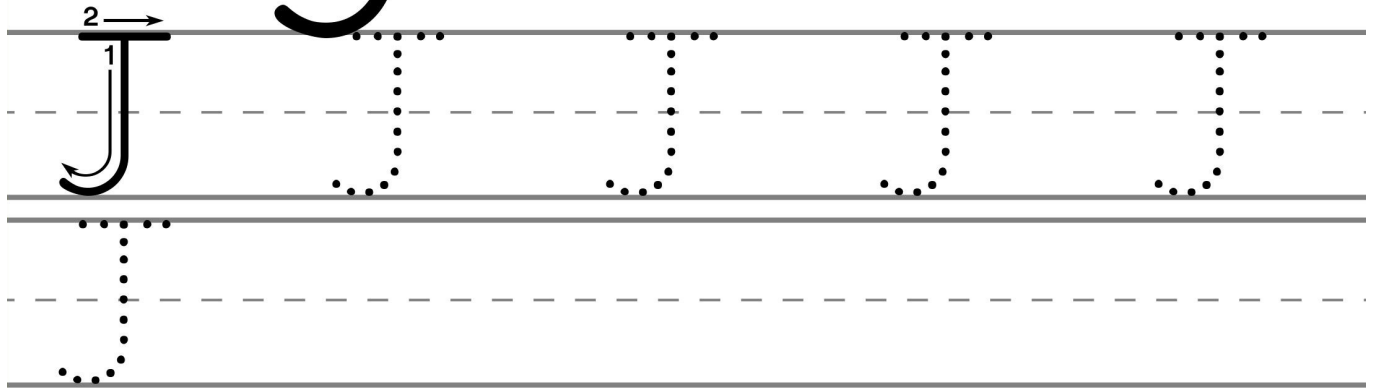
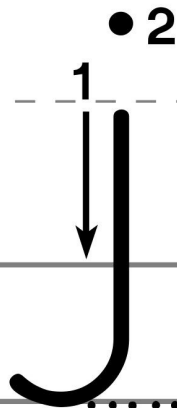
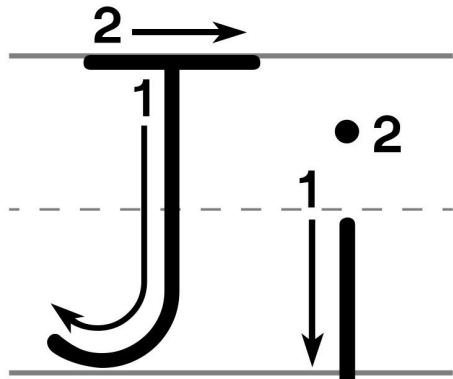

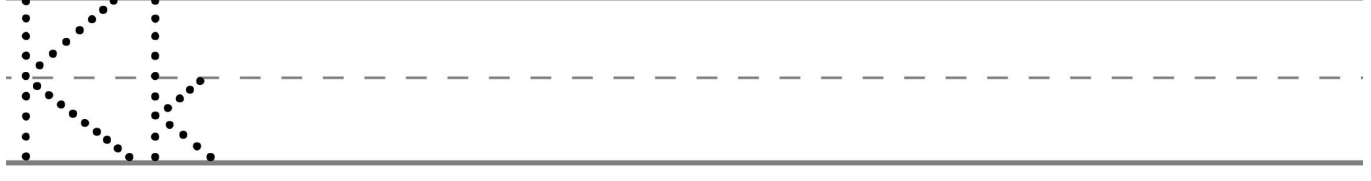
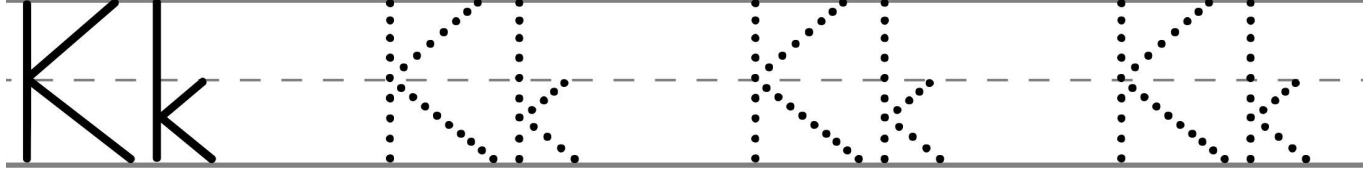
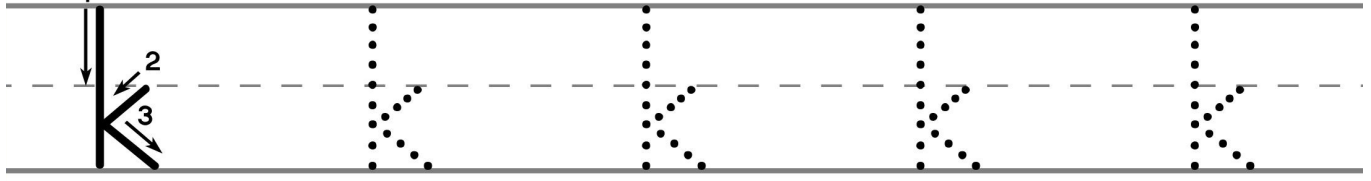
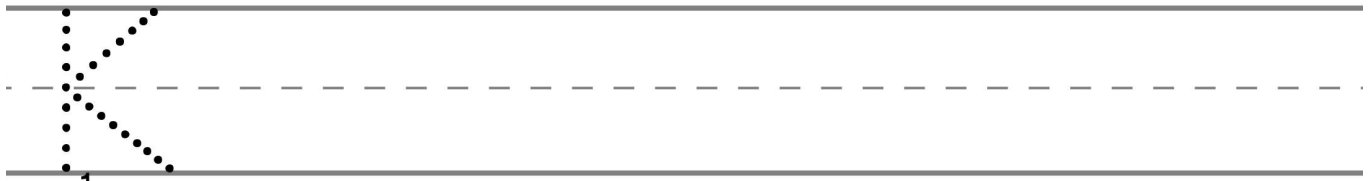
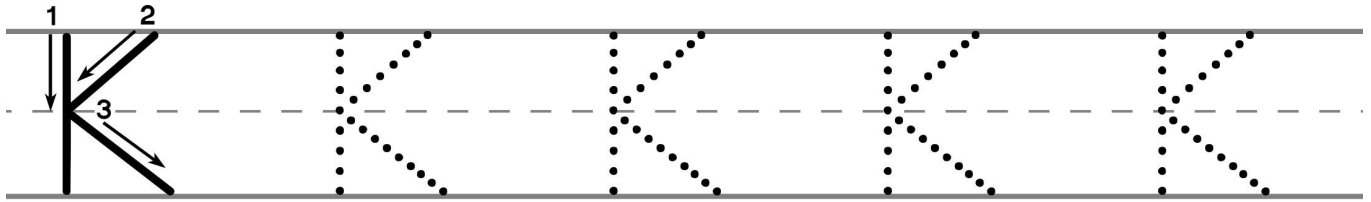
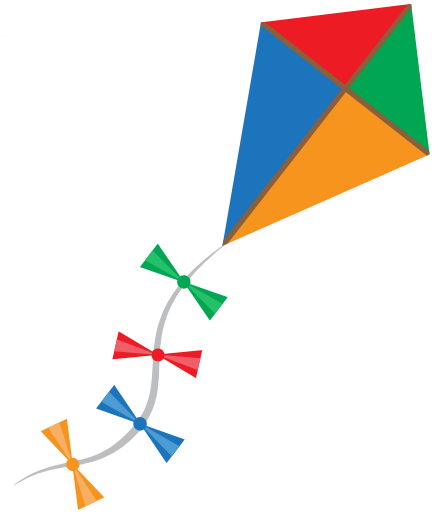
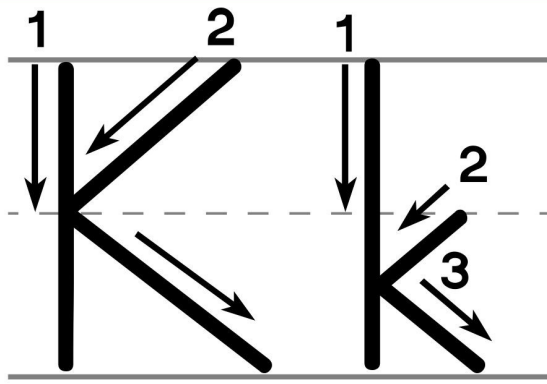

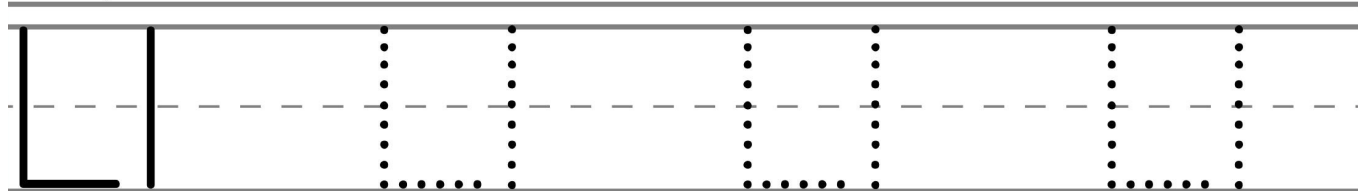
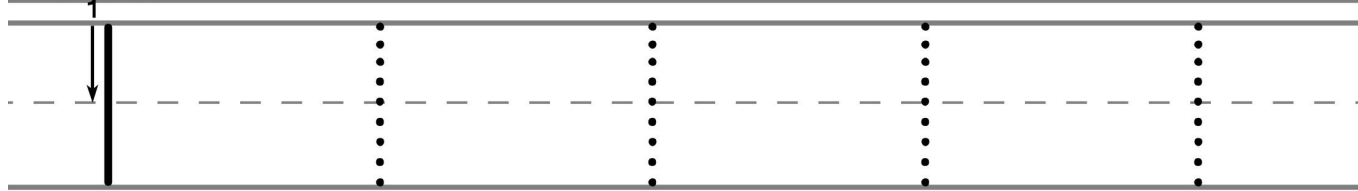
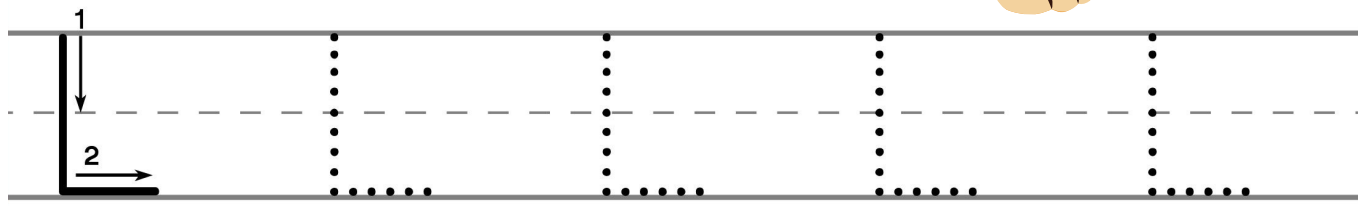
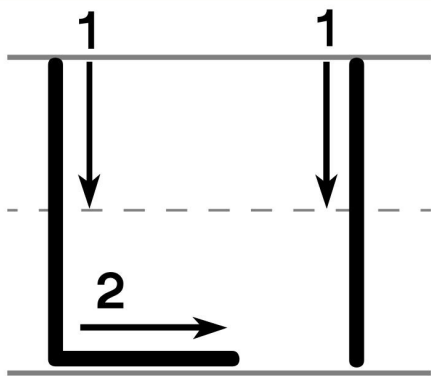

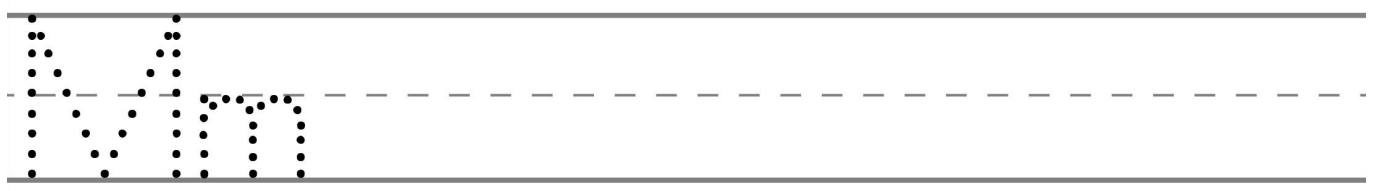
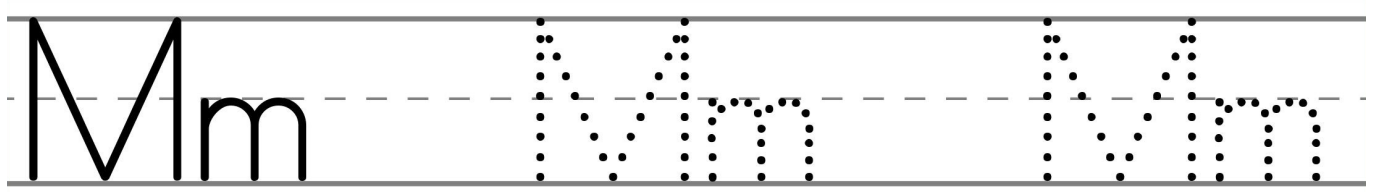
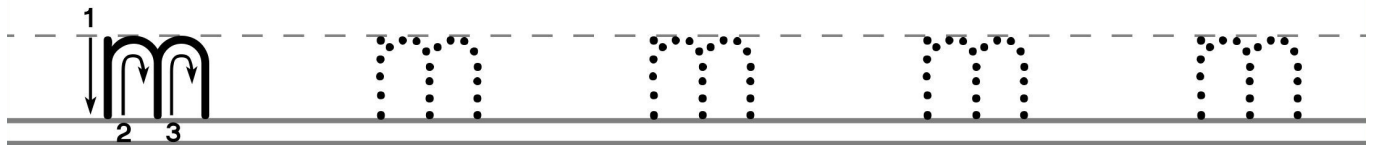
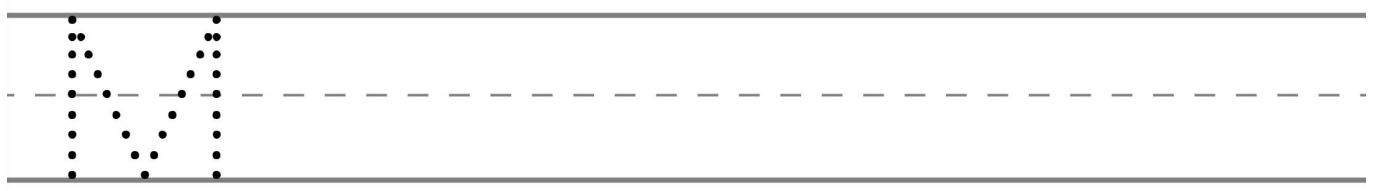
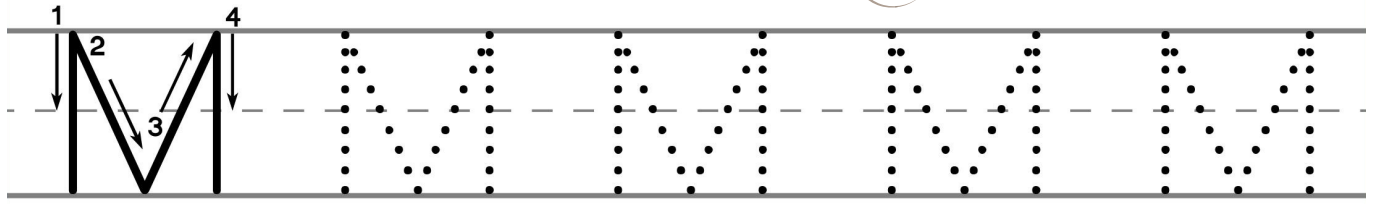
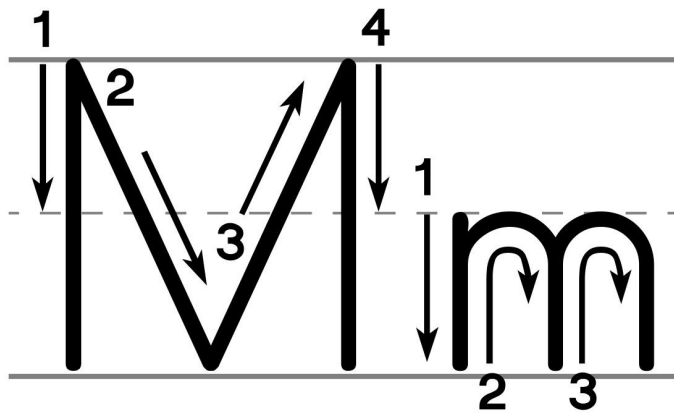

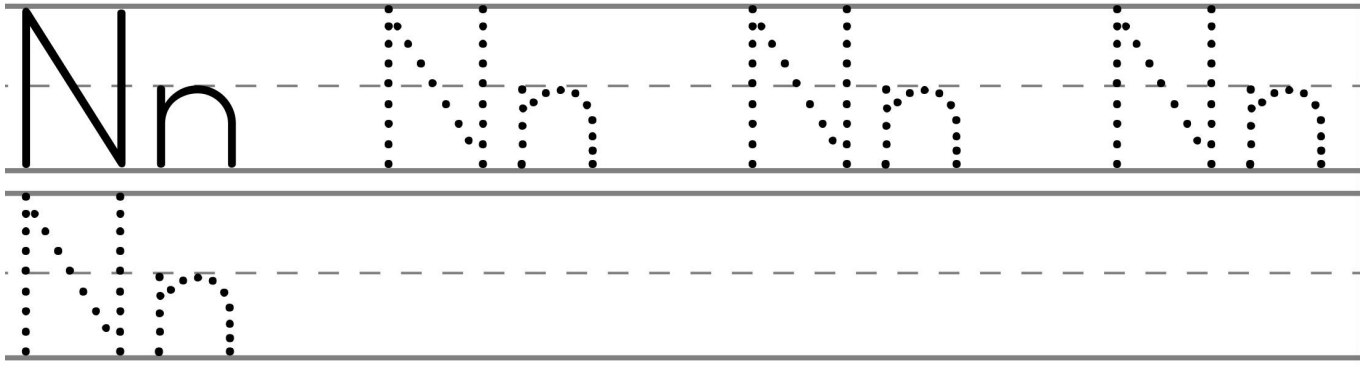
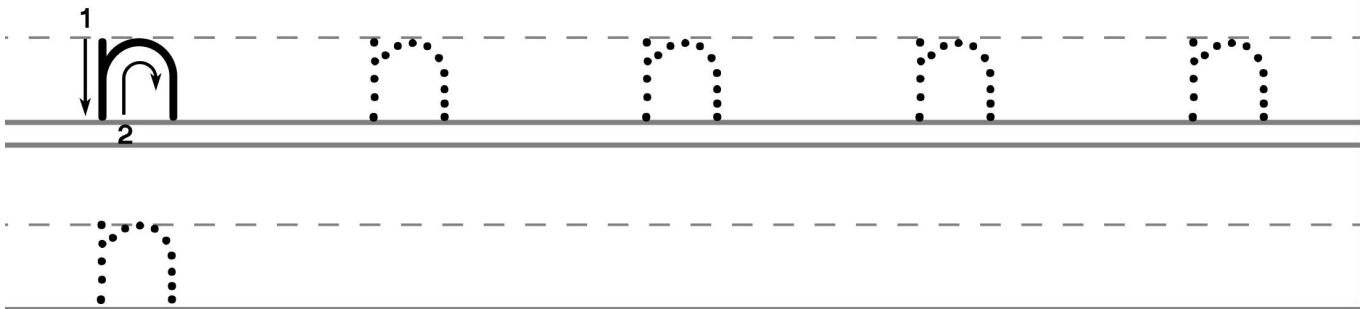
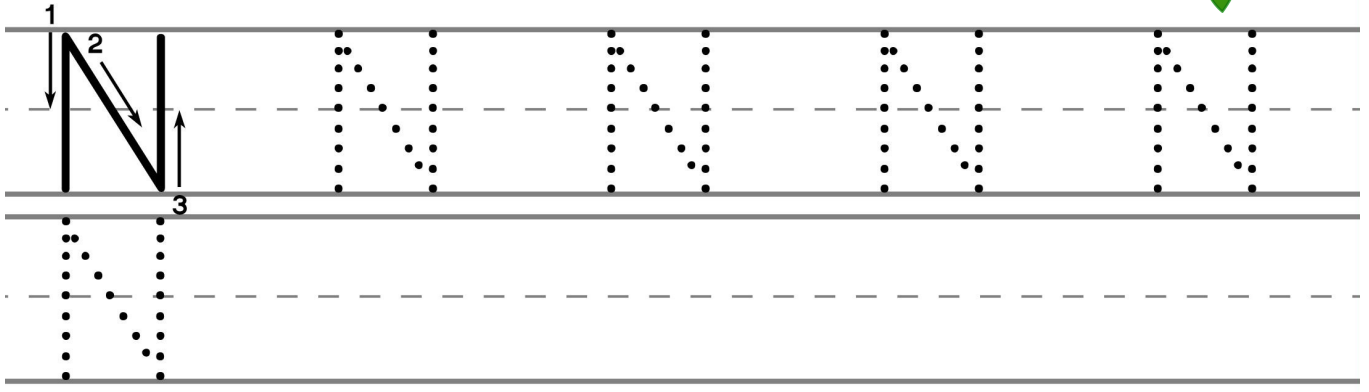
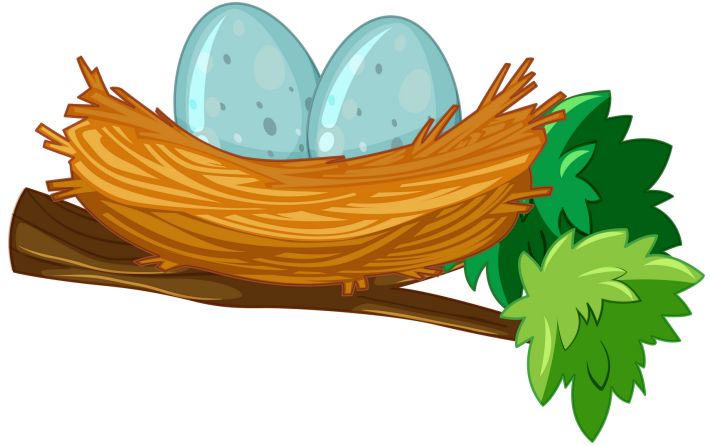
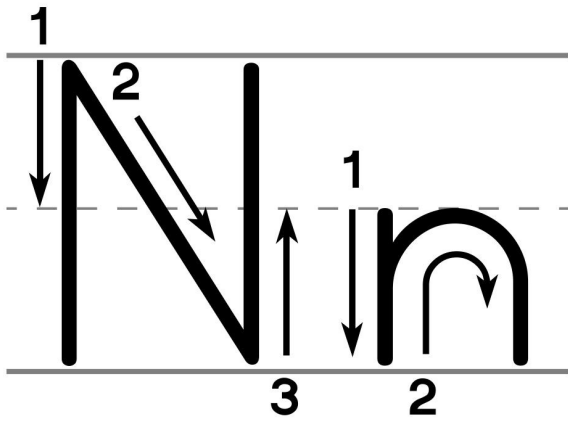

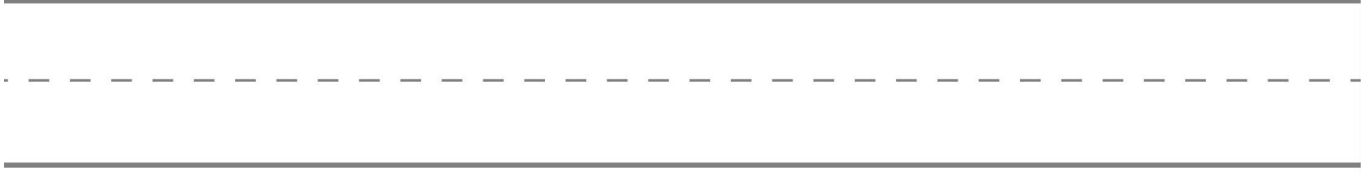
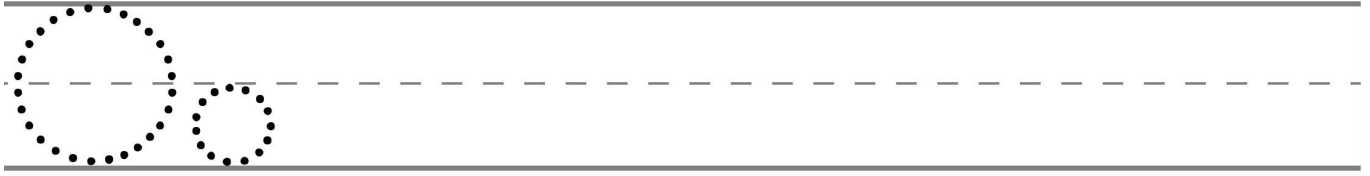
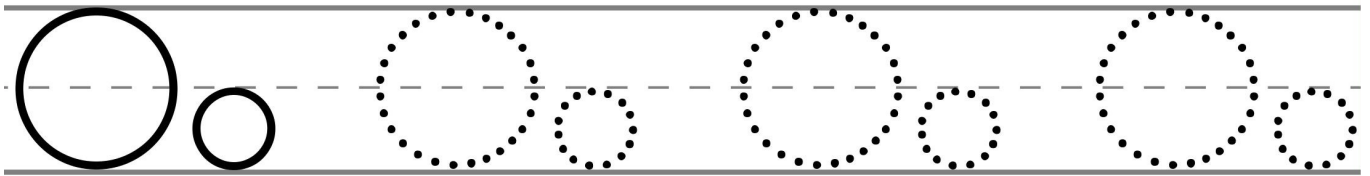
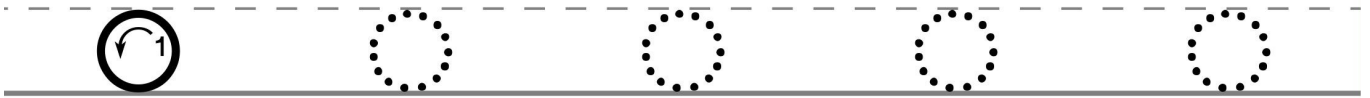
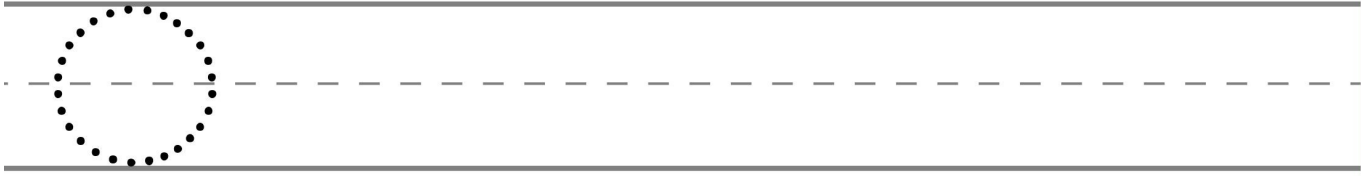
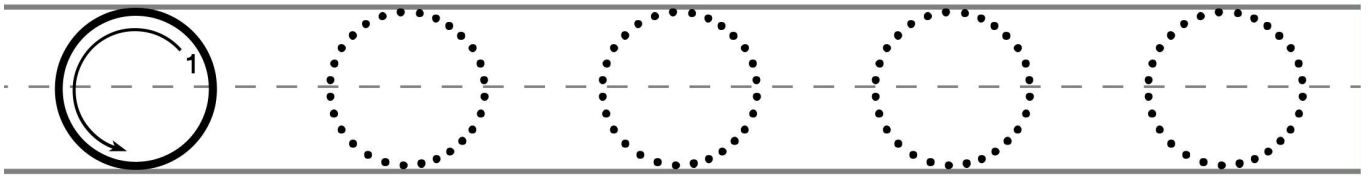
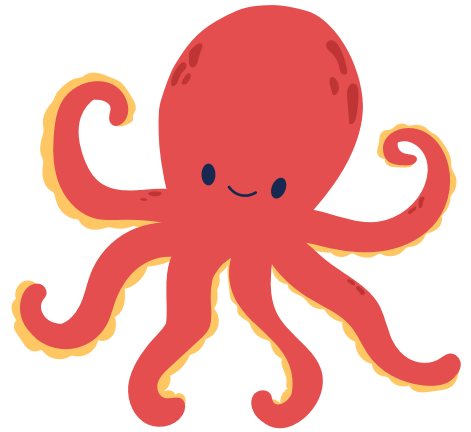
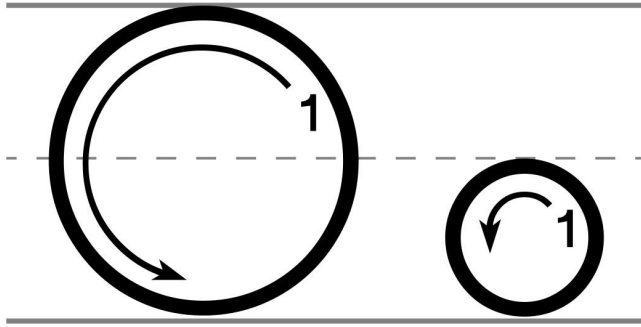

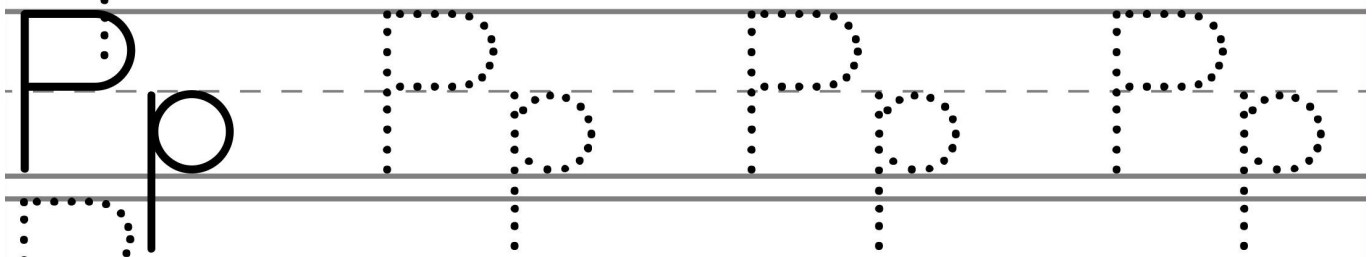
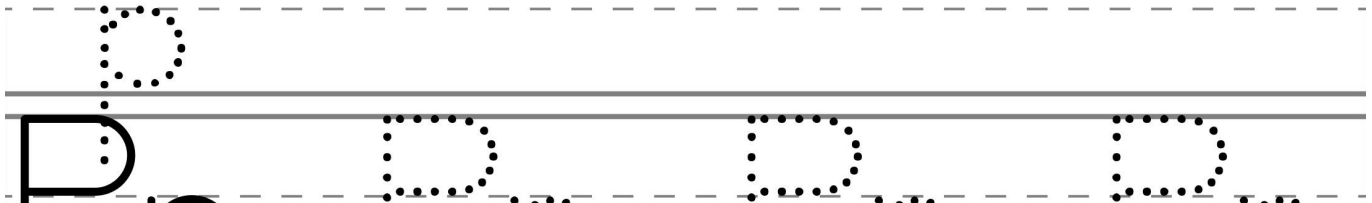
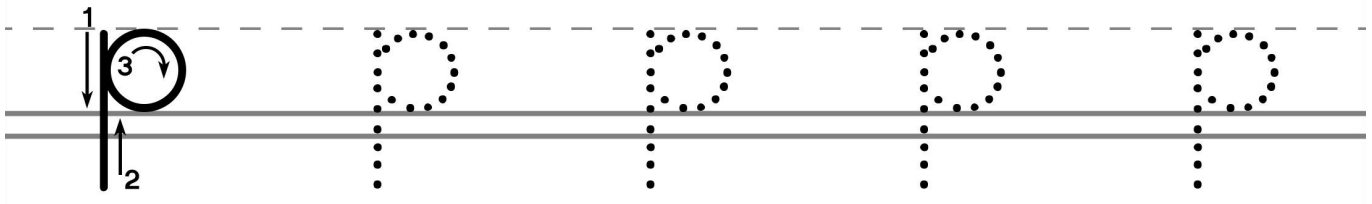
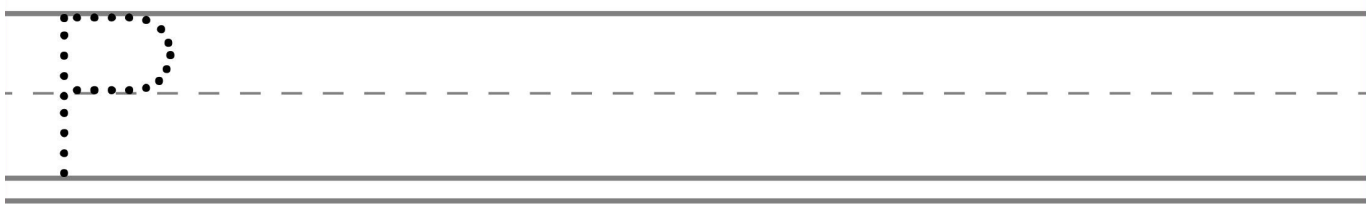
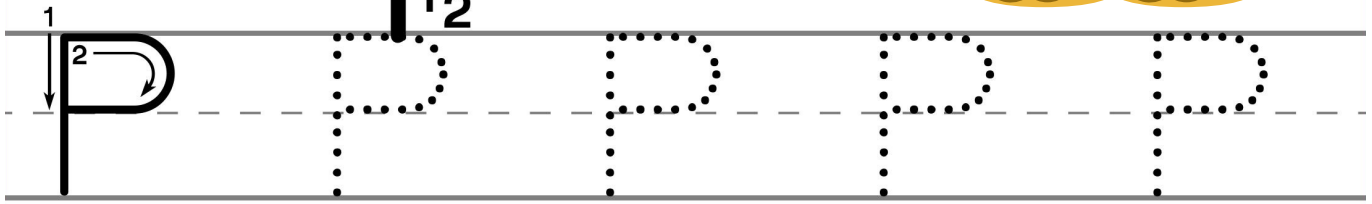
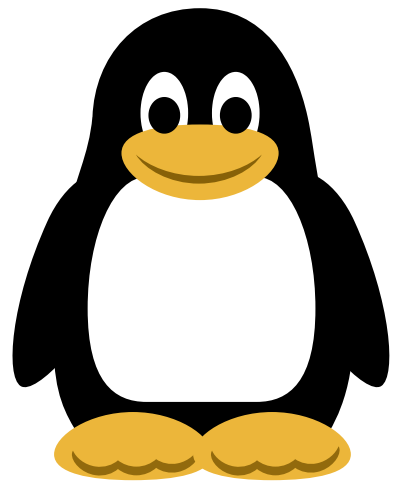
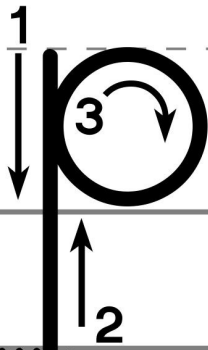
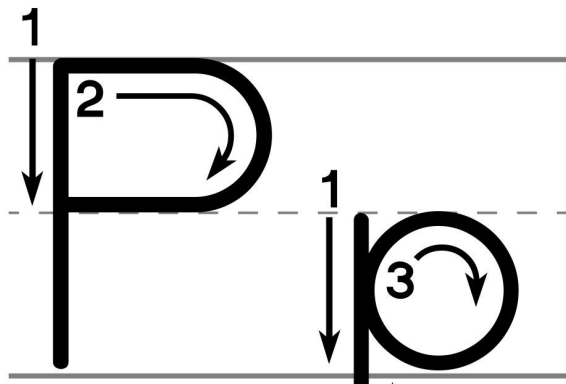



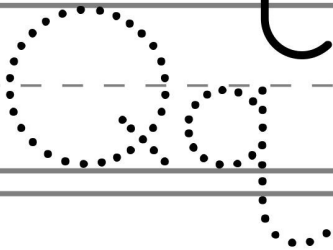
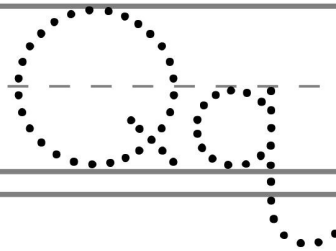
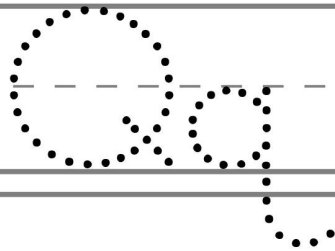
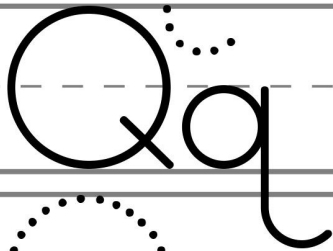
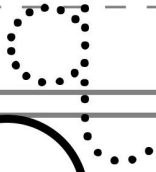
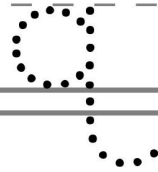
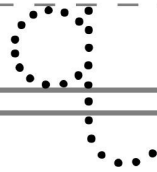
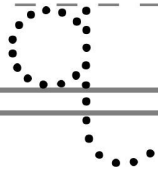
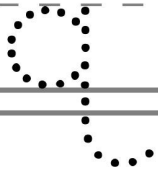
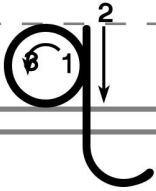
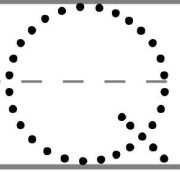
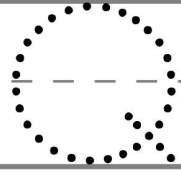
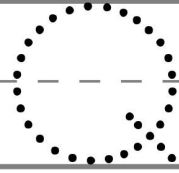
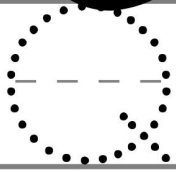
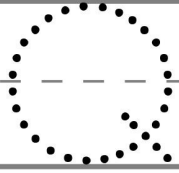
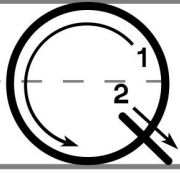
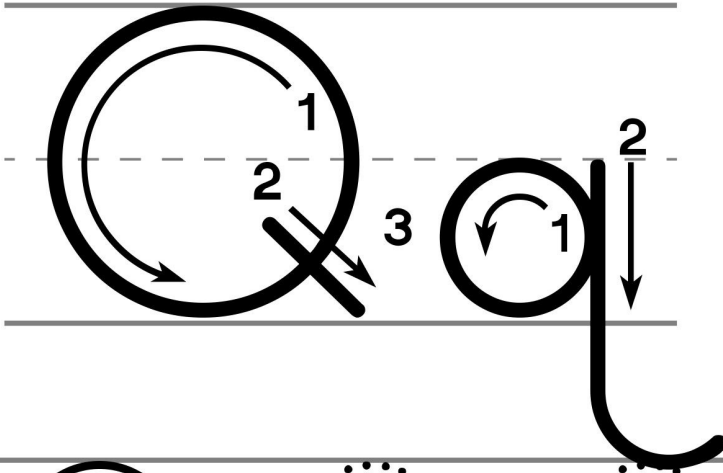

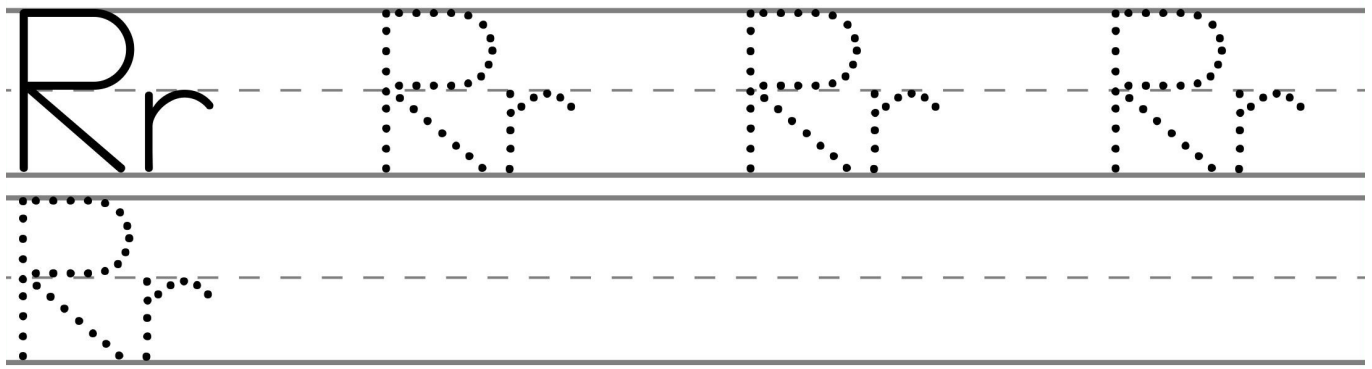
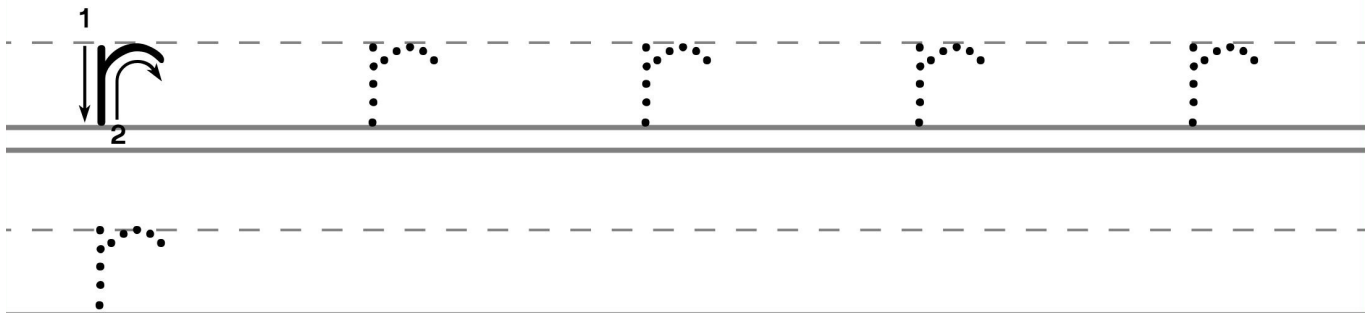
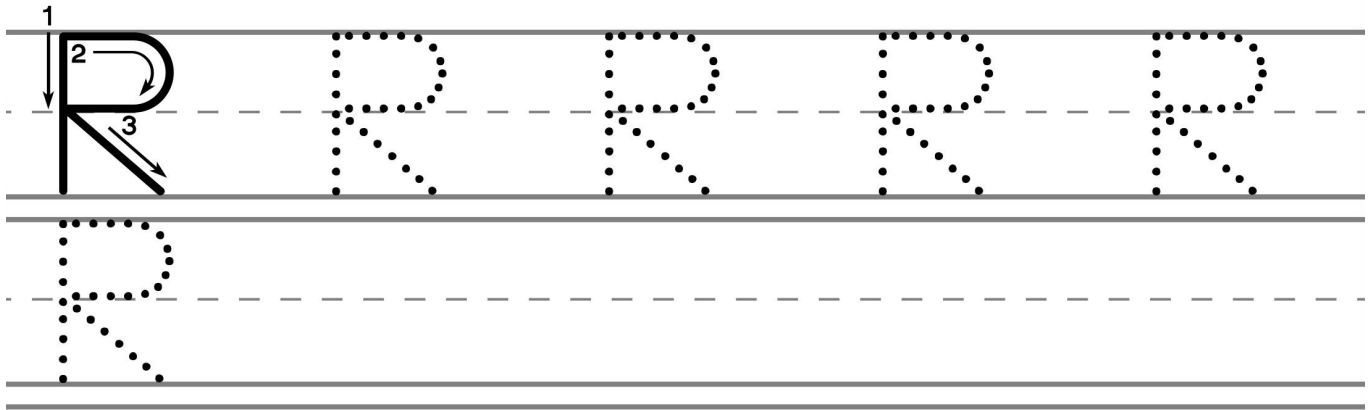
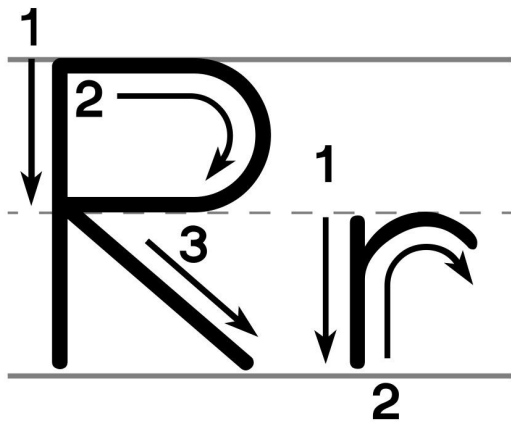

S s

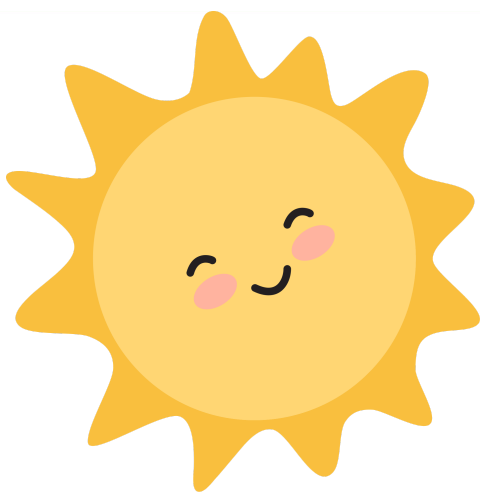

S S S S S

S

s s s s s

s

Ss Ss Ss

Ss

