

Color the drawing and trace the word

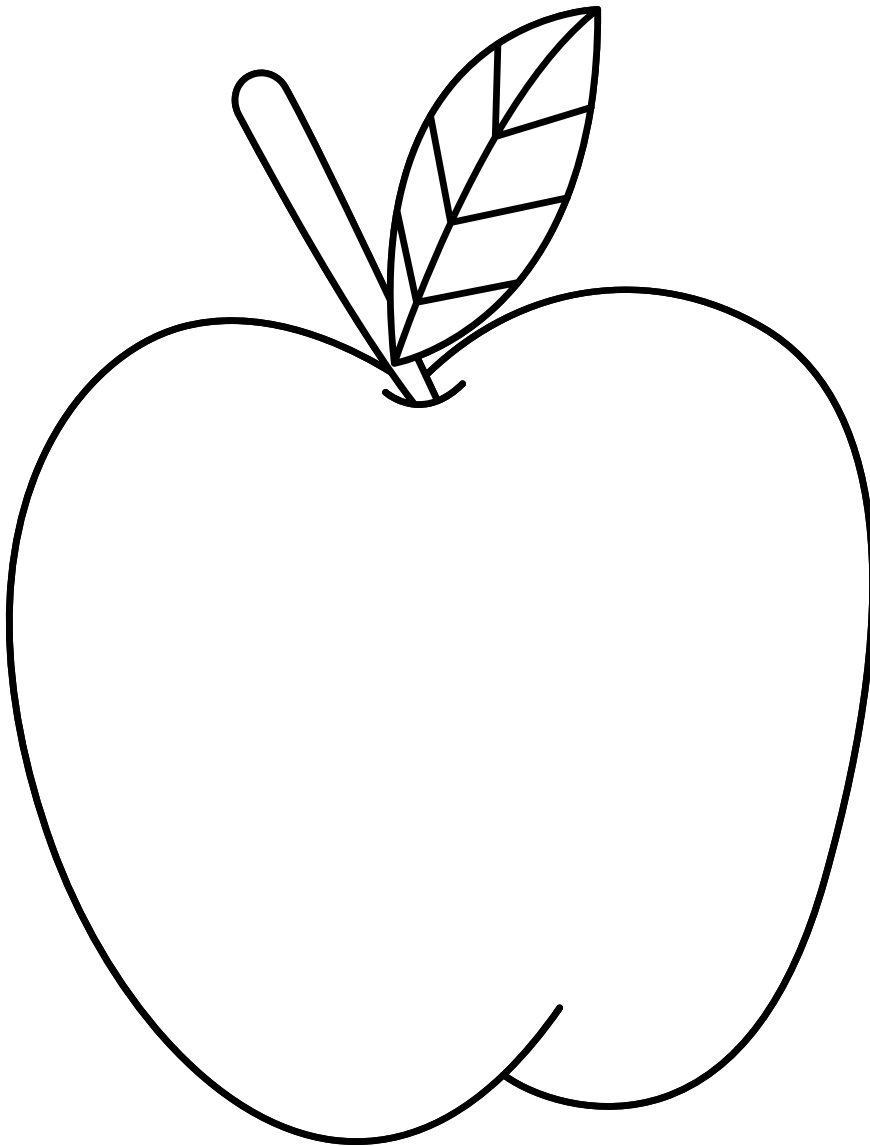

A p p l e

Color the drawing and trace the word

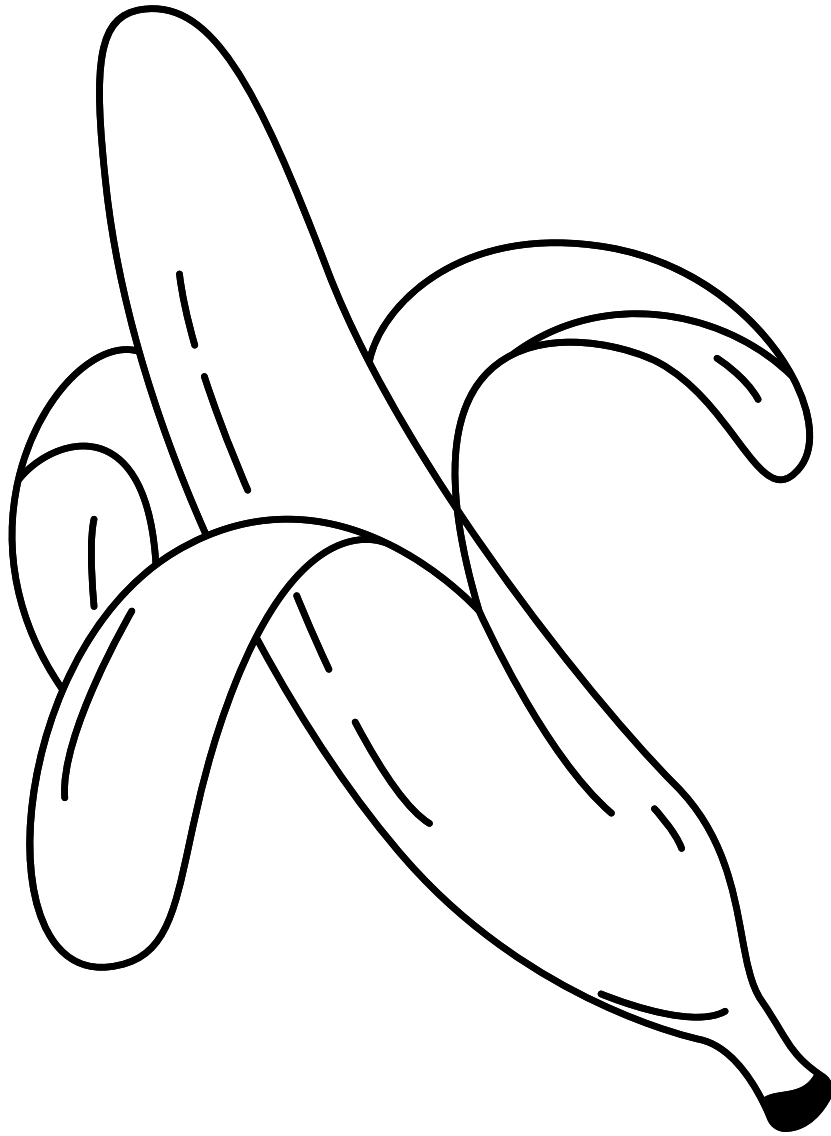

Banana

Color the drawing and trace the word

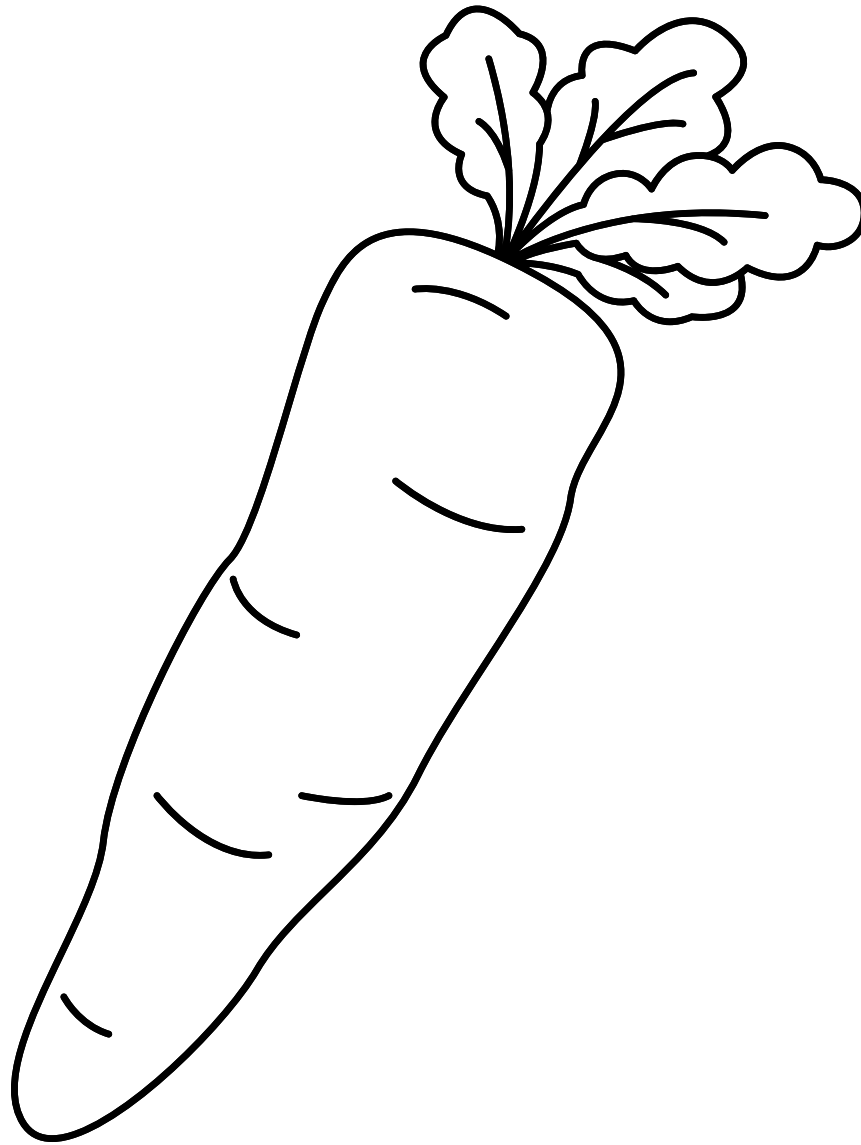

Carrot

Color the drawing and trace the word

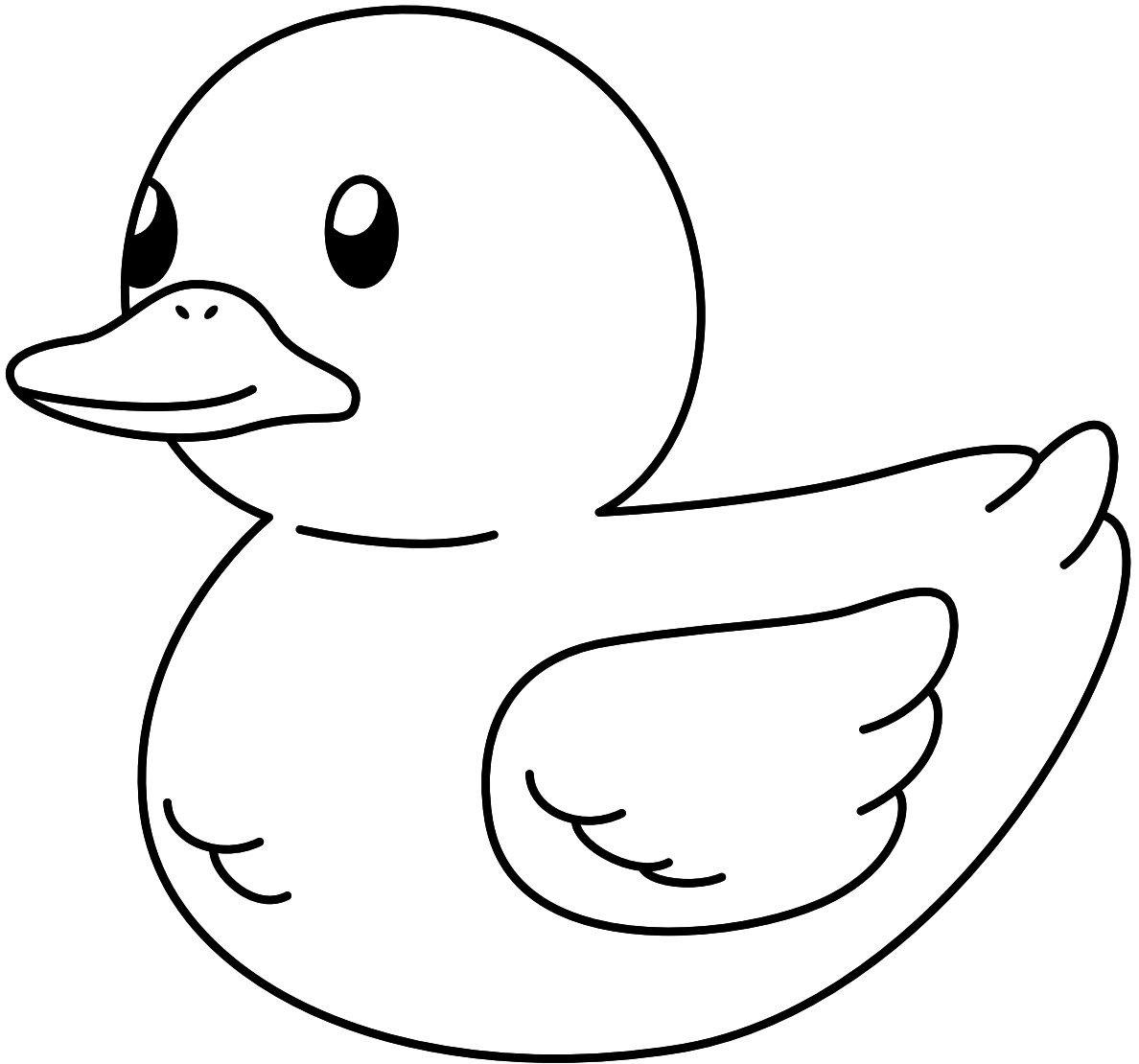

Duck

Color the drawing and trace the word

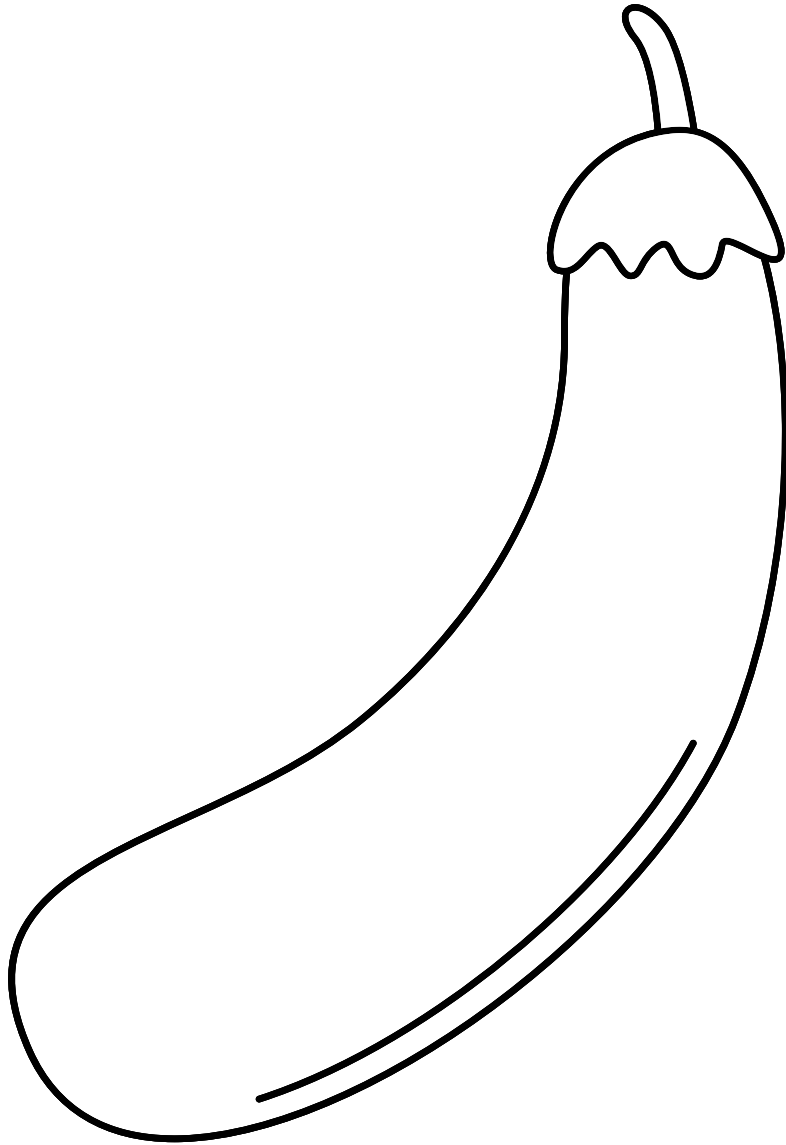

Eggplant

Color the drawing and trace the word

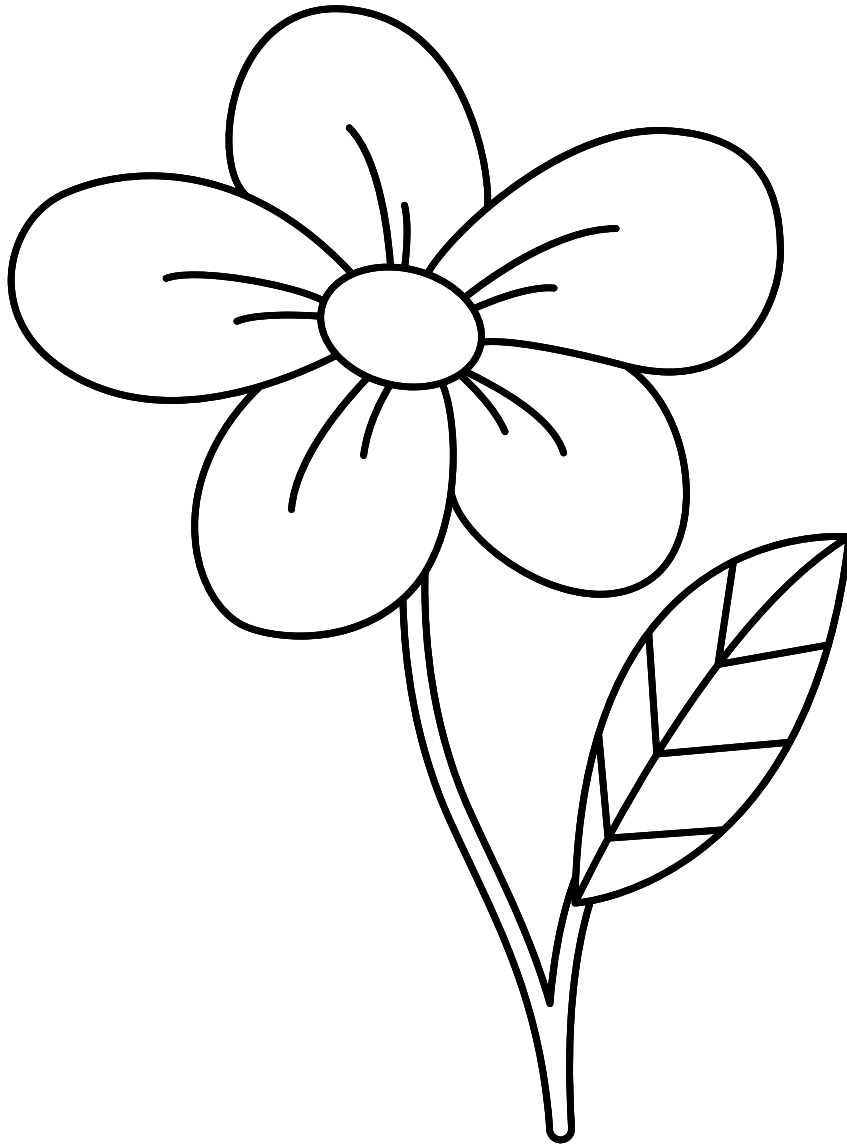

flower

Color the drawing and trace the word

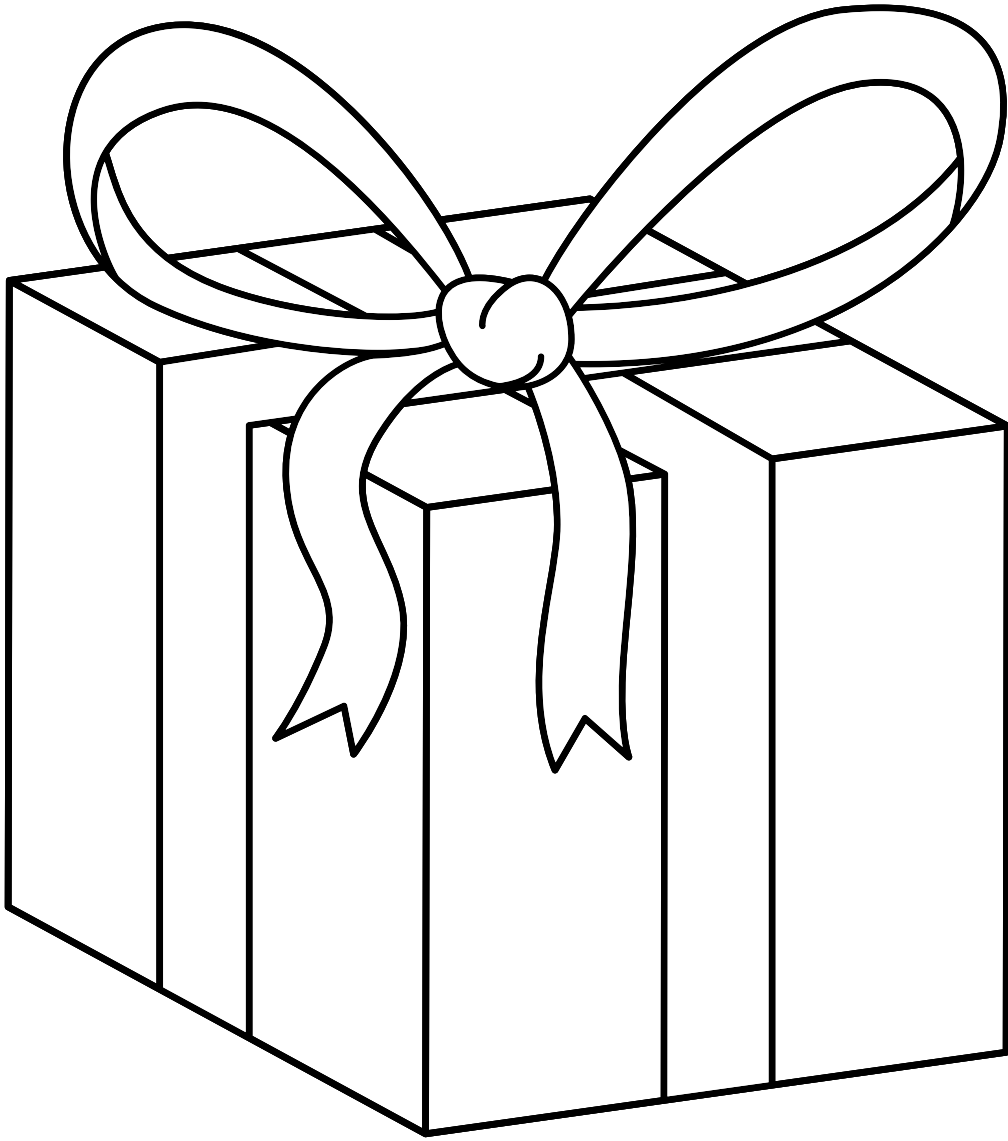

Gift

Color the drawing and trace the word

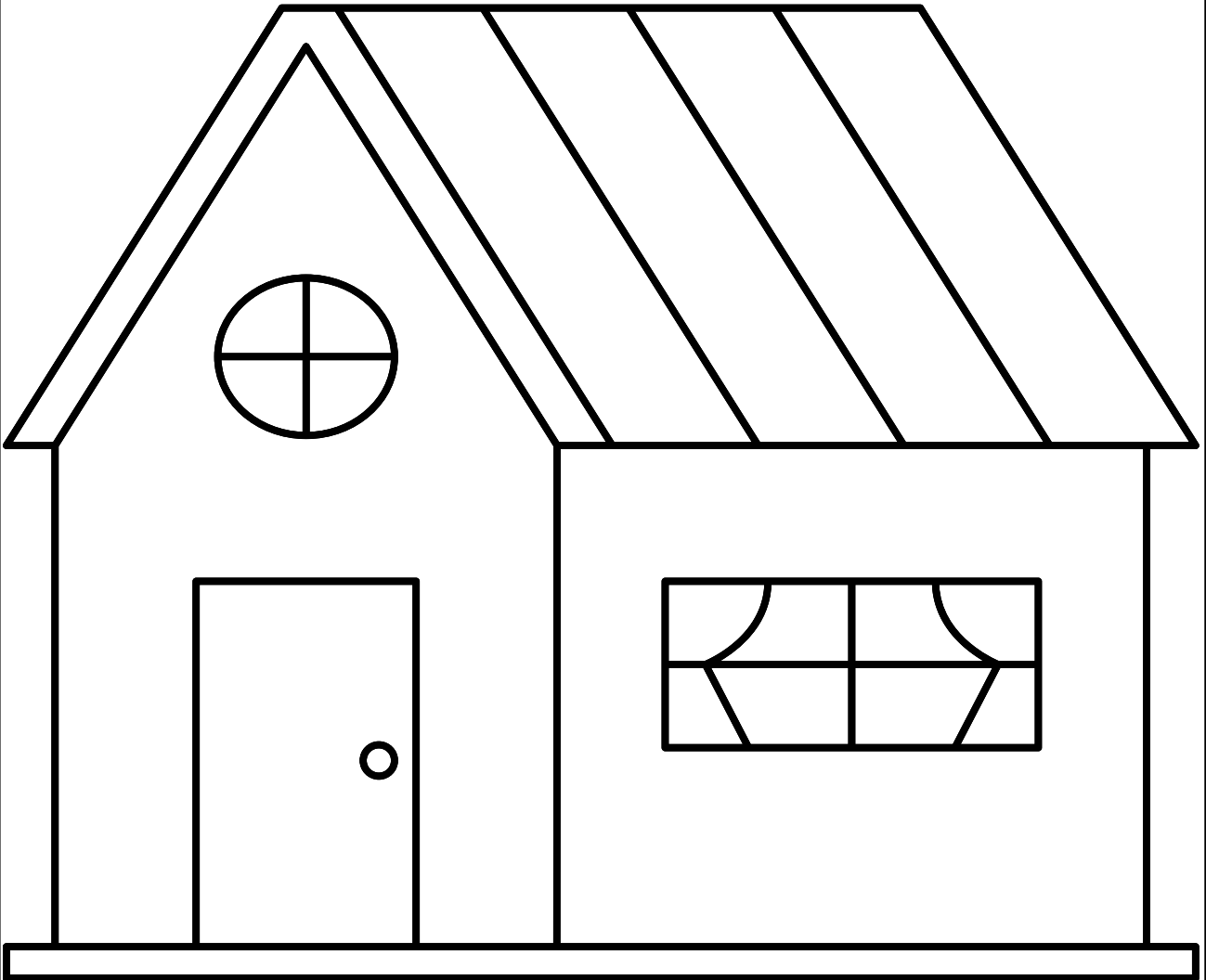

house



Color the drawing and trace the word

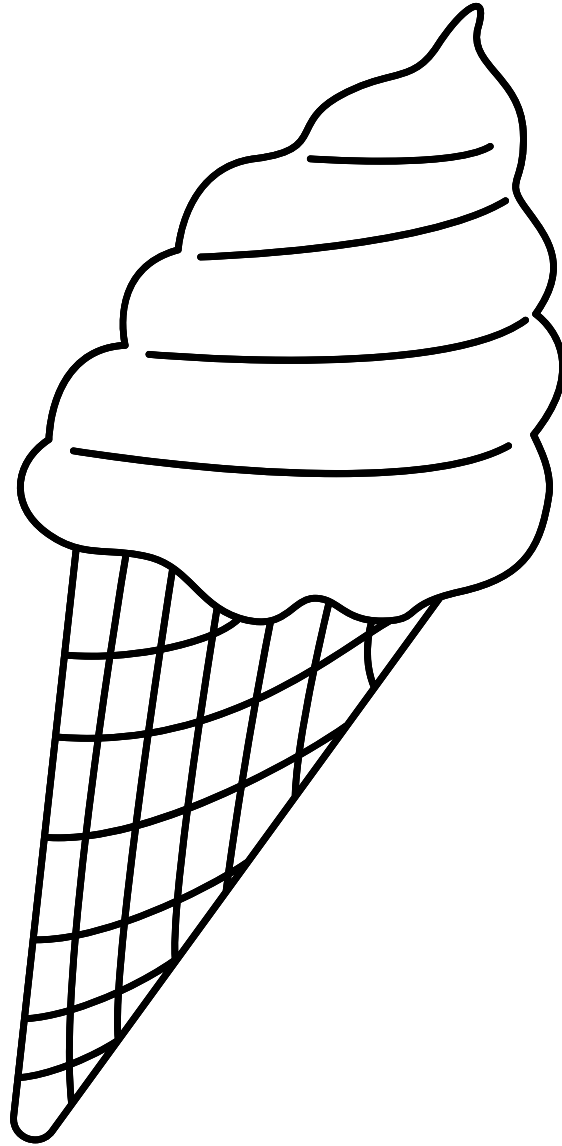

Ice Cream

Color the drawing and trace the word

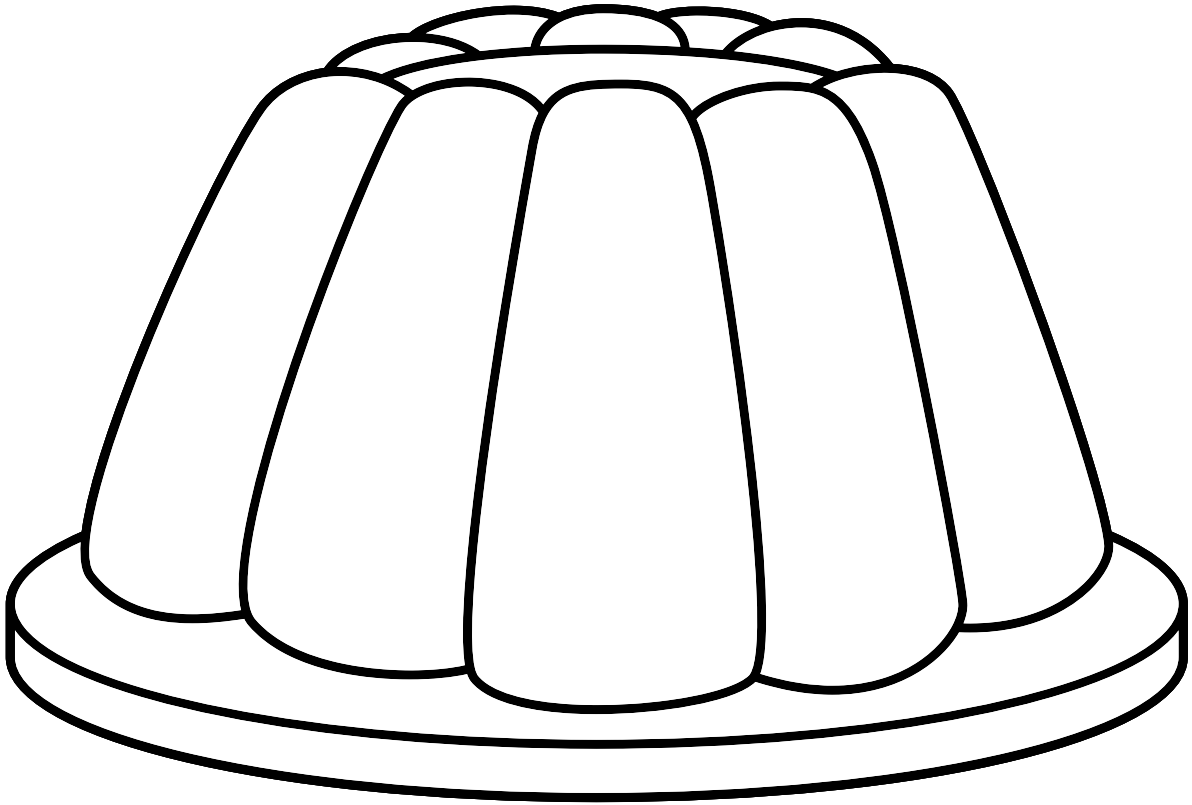

Jelly

Color the drawing and trace the word

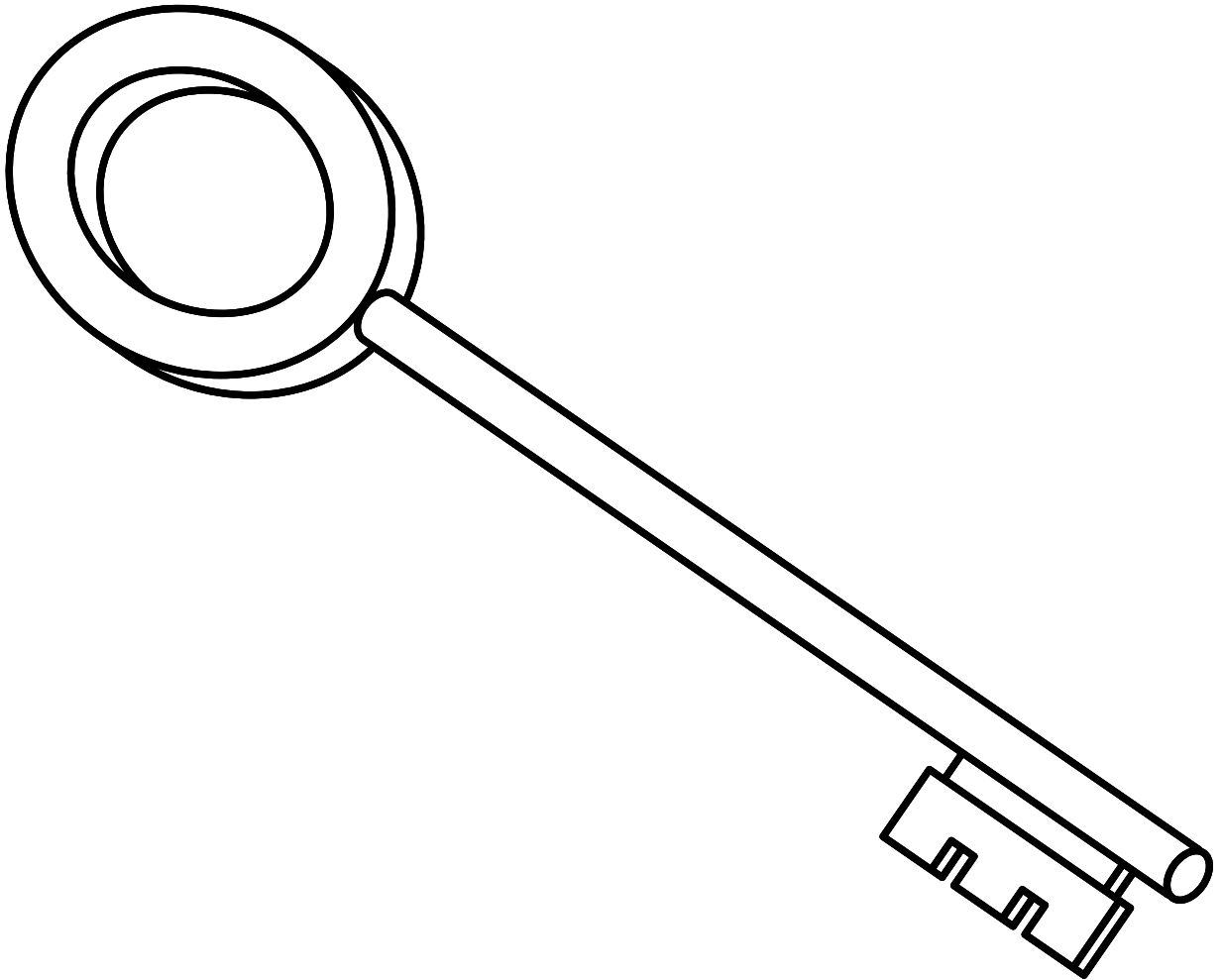

Key

Color the drawing and trace the word

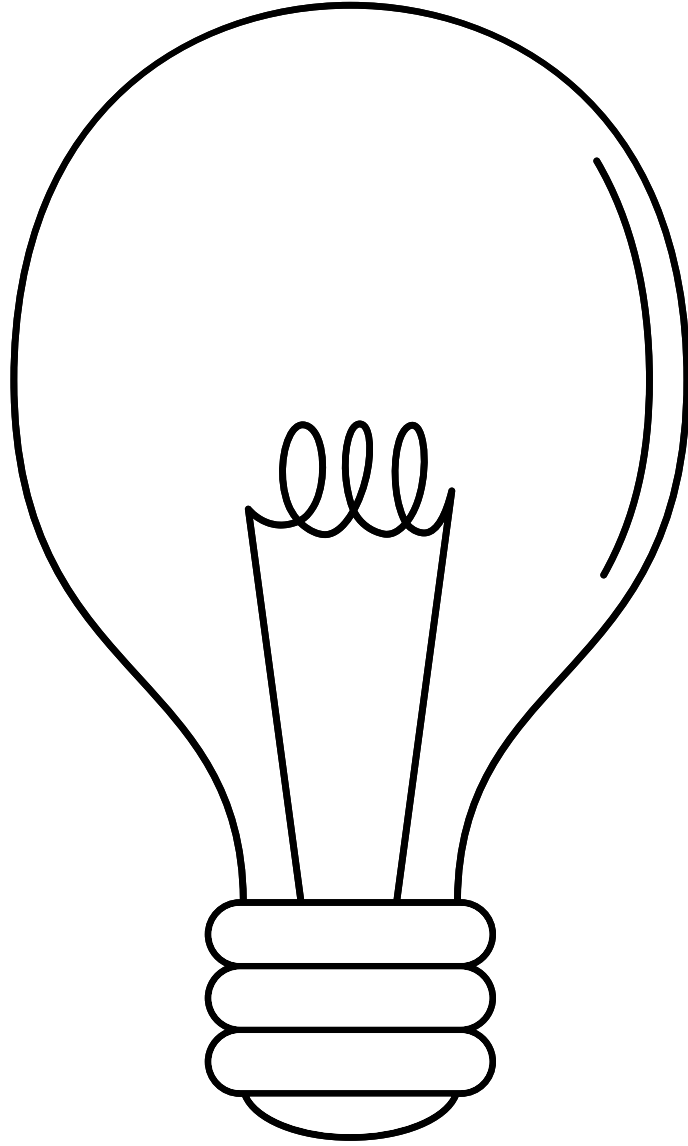

Light Bulb

Color the drawing and trace the word

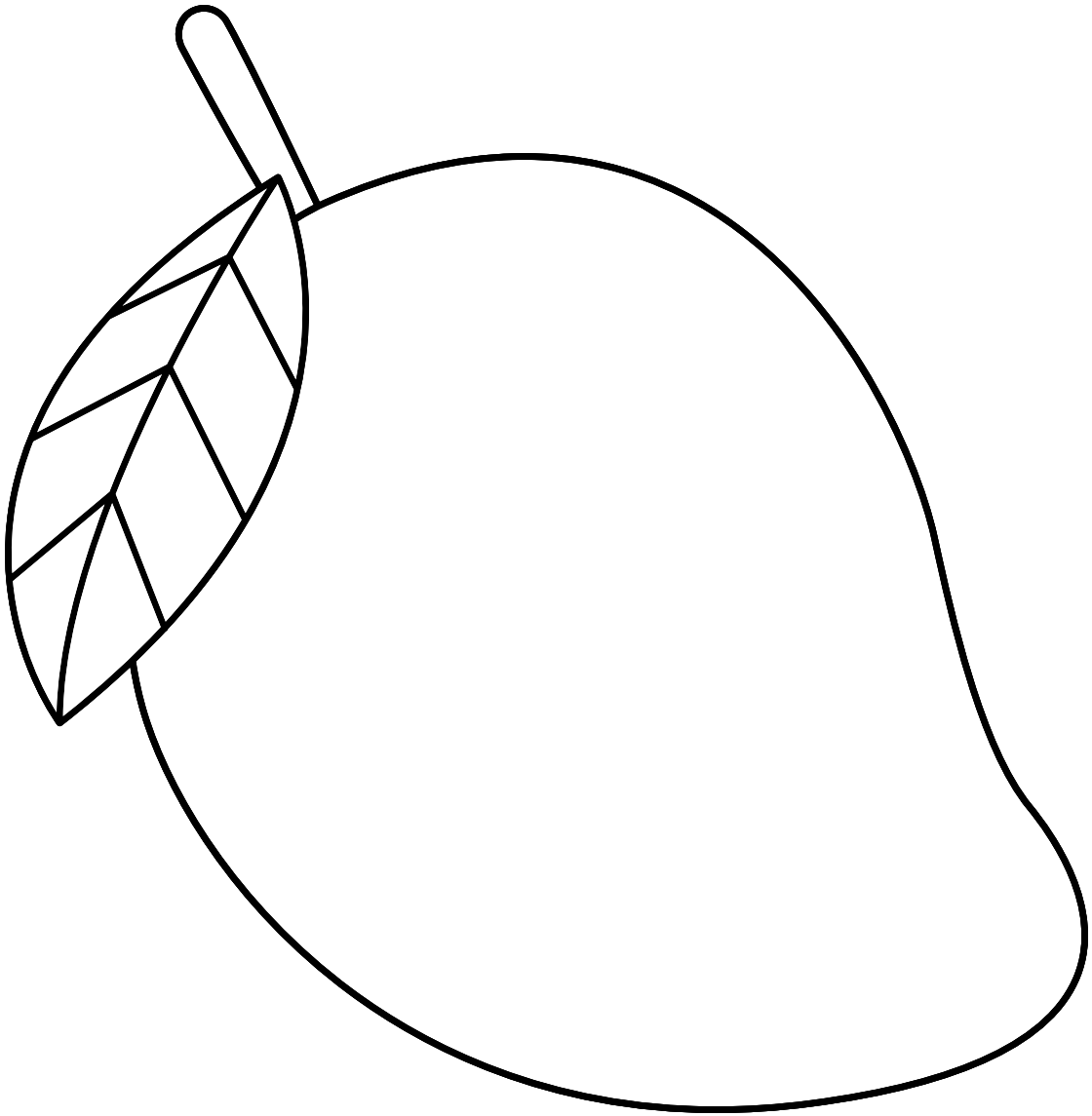

Mango

Color the drawing and trace the word

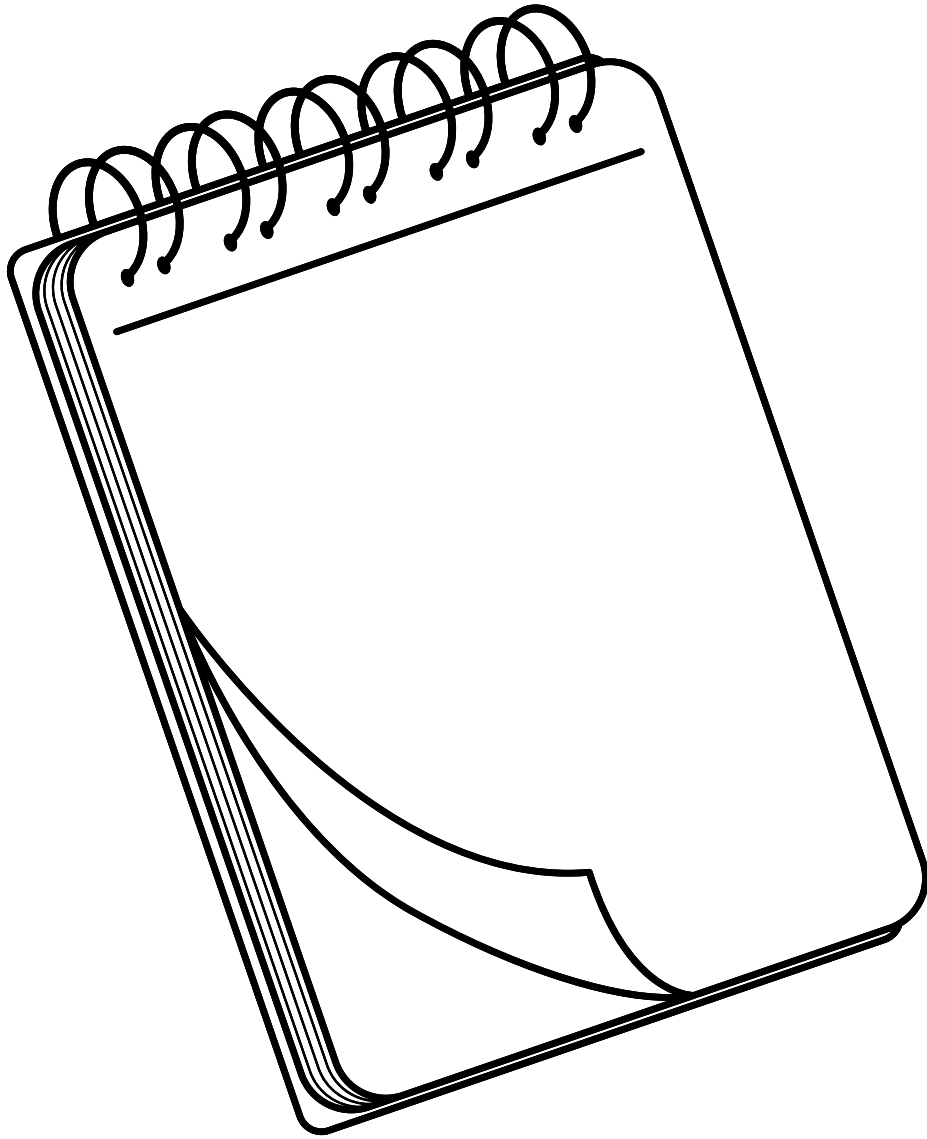

Notepad

Color the drawing and trace the word

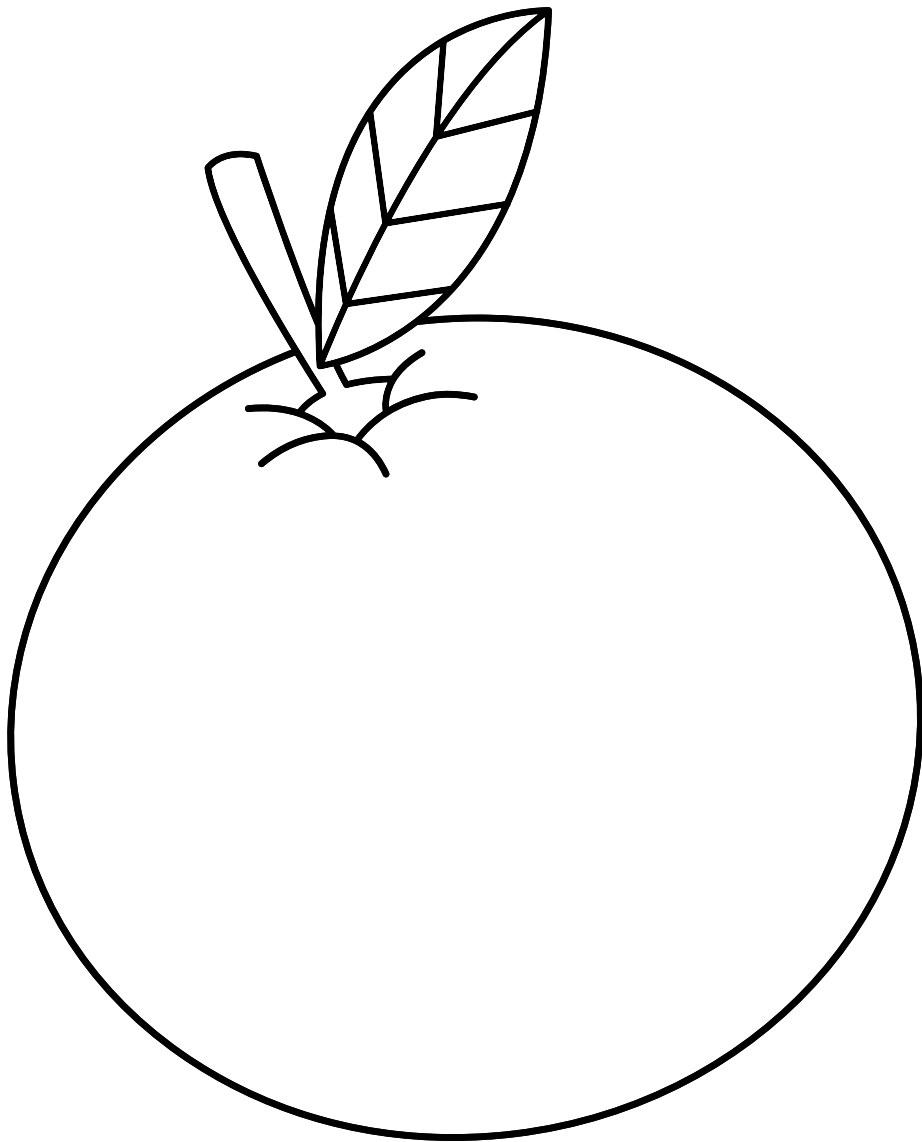

Orange

Color the drawing and trace the word

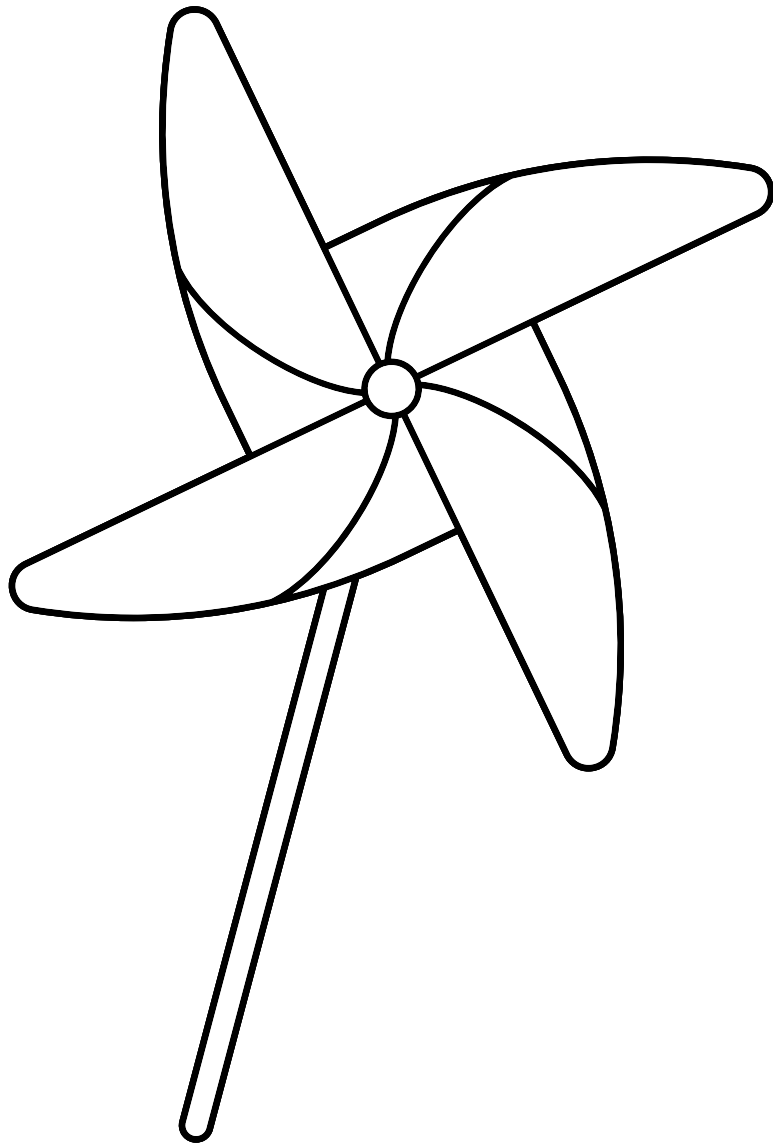

Pinwheel



Color the drawing and trace the word

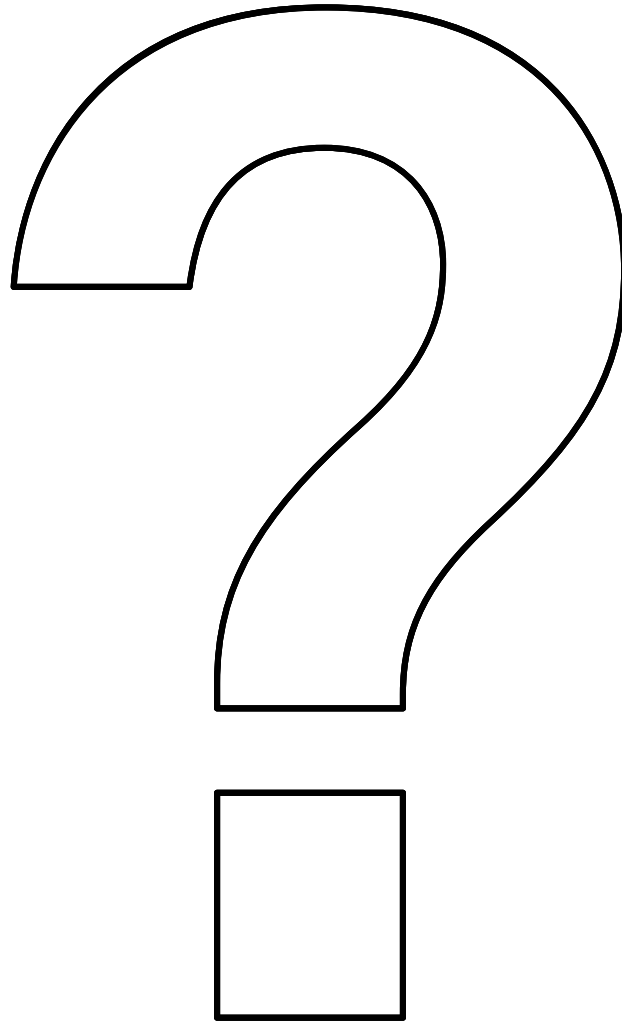

Question

Mark

Color the drawing and trace the word

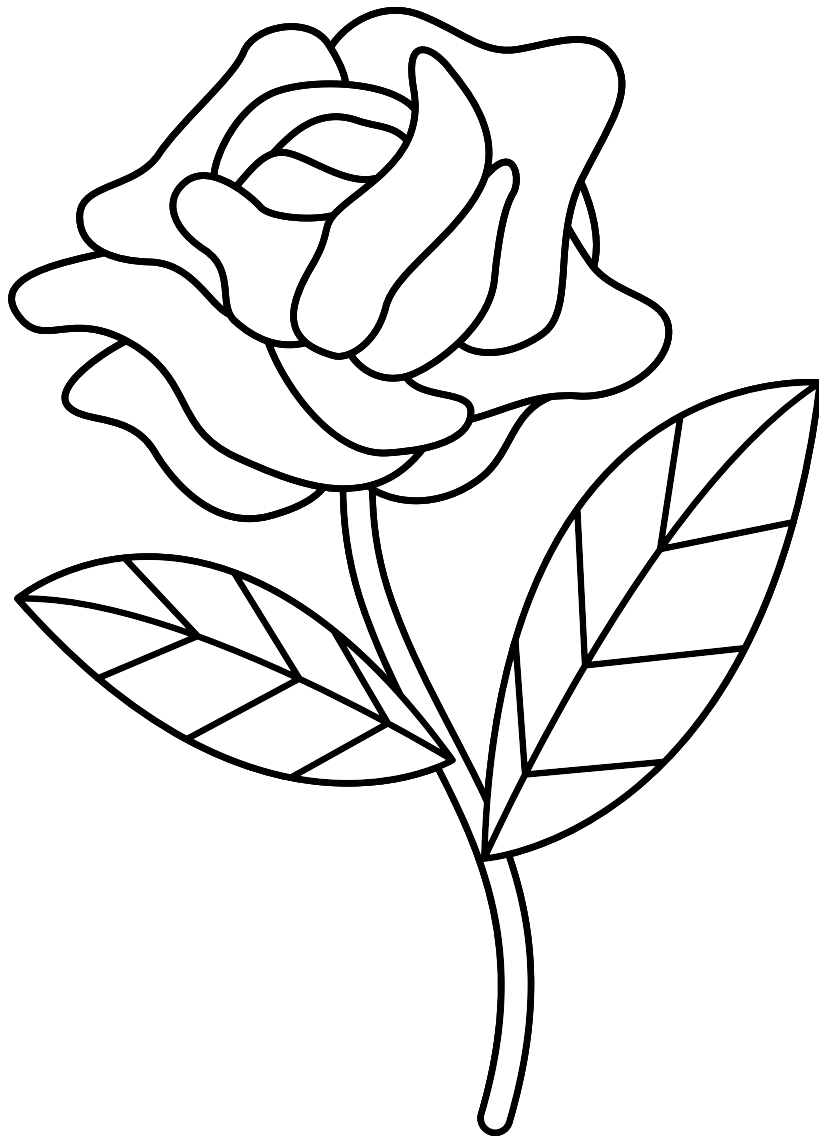

Rose

Color the drawing and trace the word

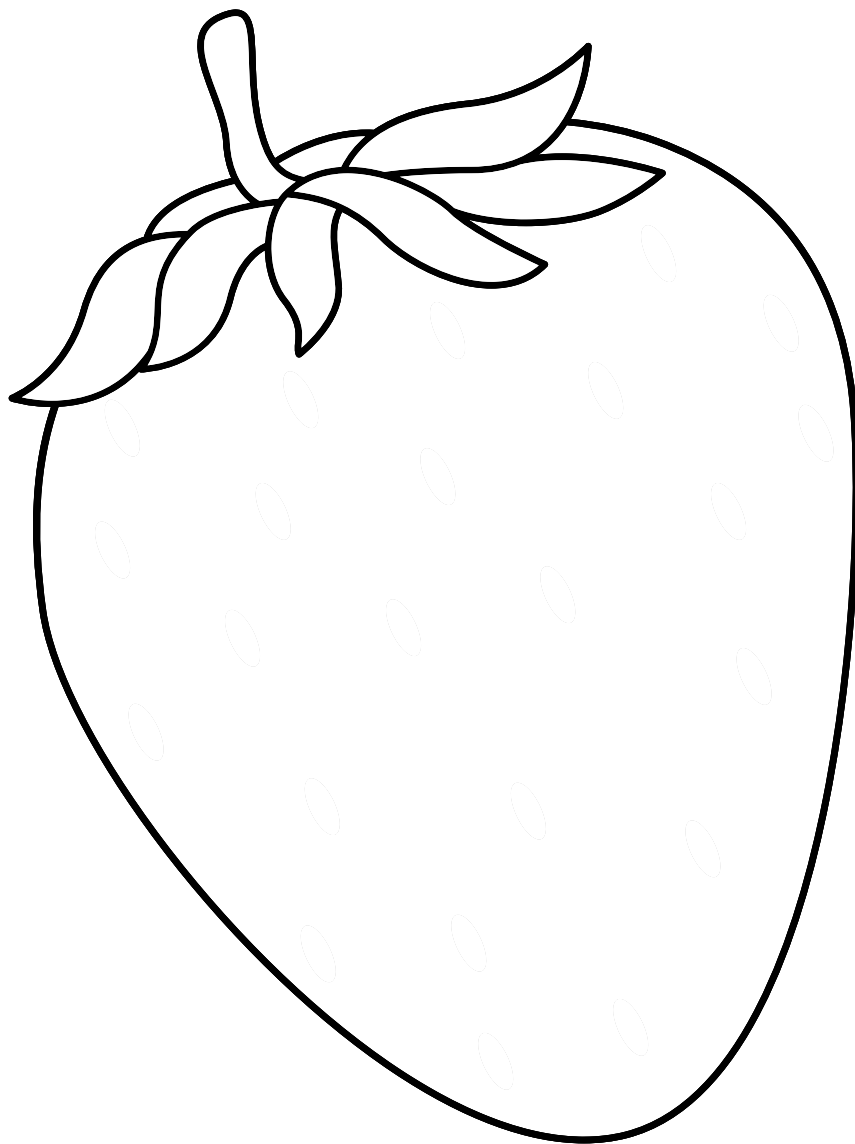

Strawberry

Color the drawing and trace the word

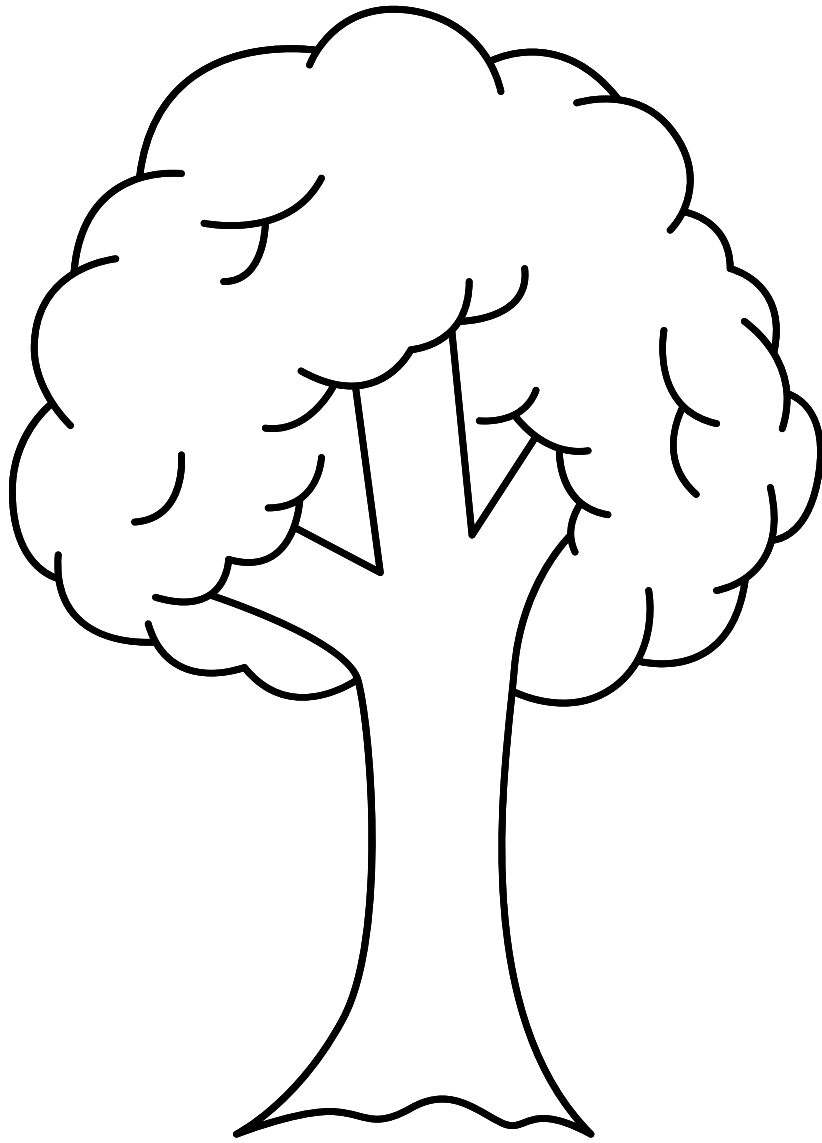

Tree

Color the drawing and trace the word



Umbrella

Color the drawing and trace the word

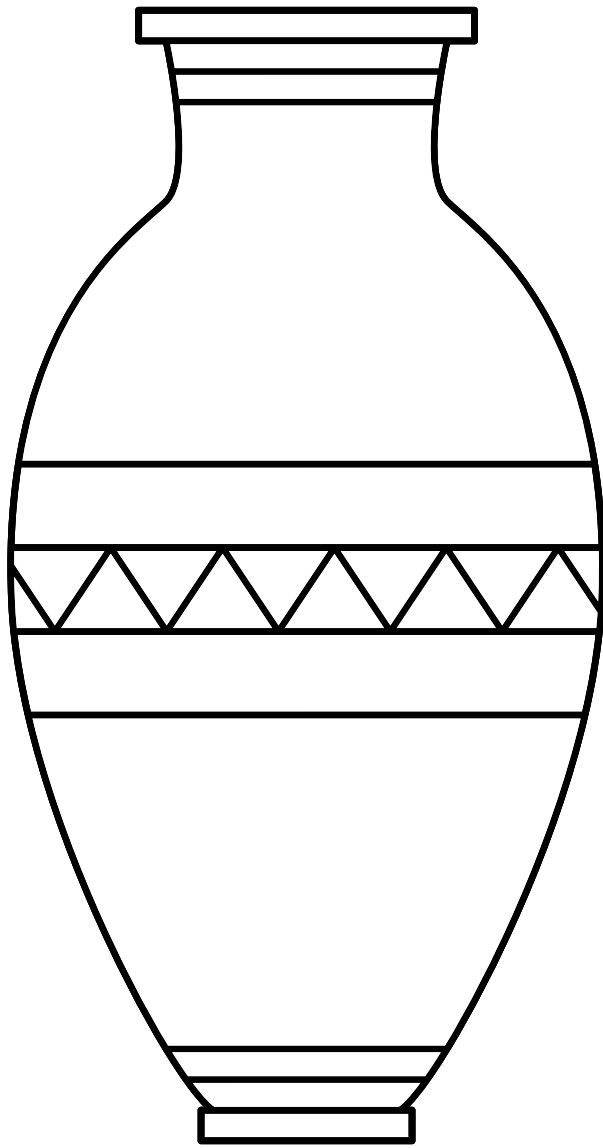

vase

Color the drawing and trace the word

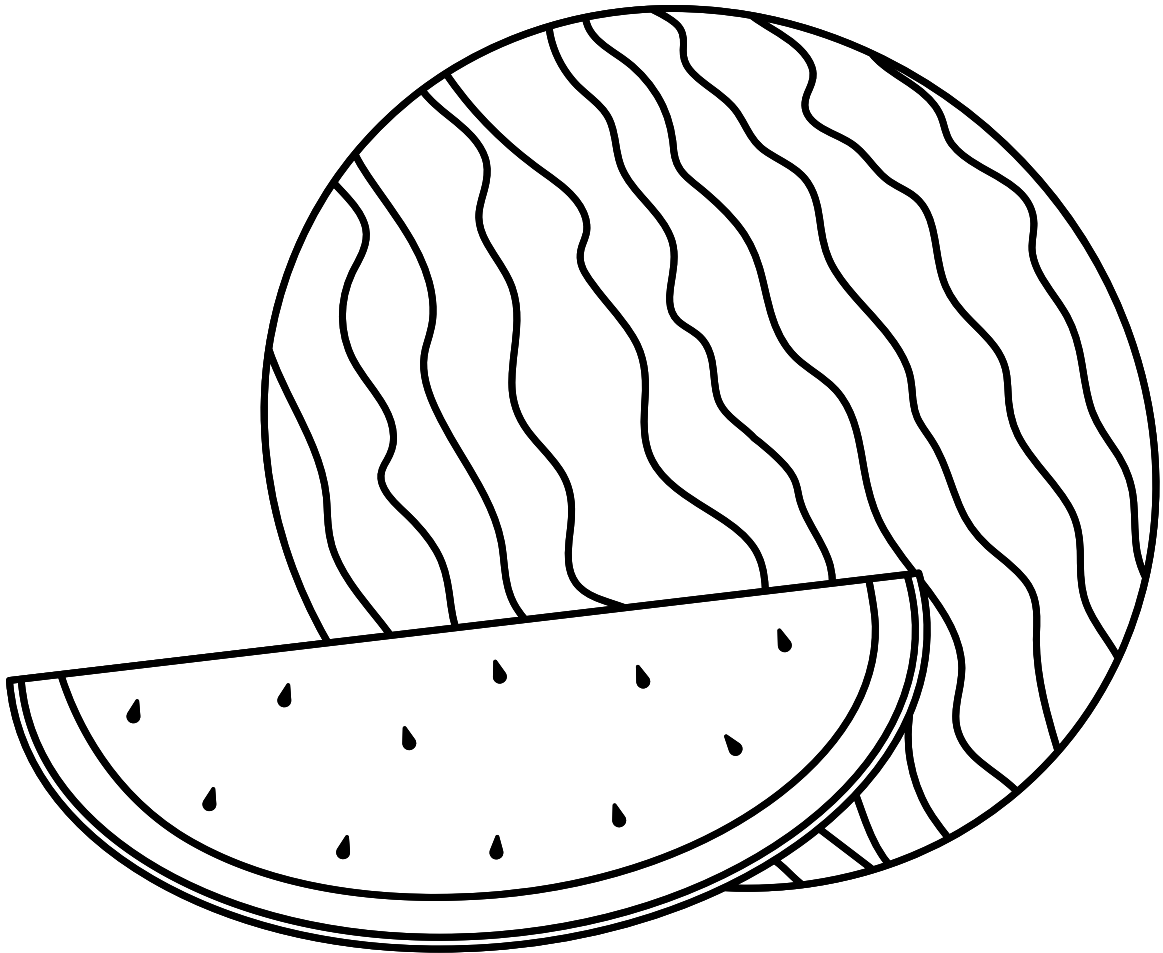

Watermelon

Color the drawing and trace the word

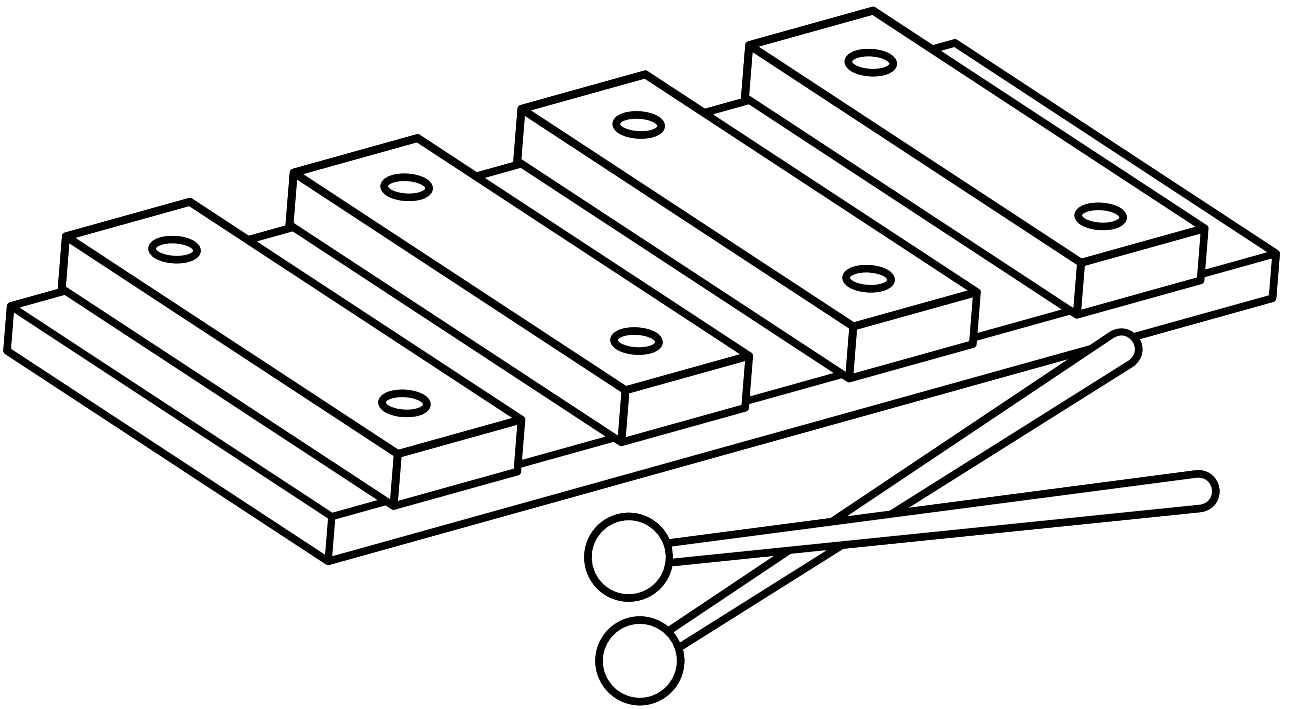

Xylophone



Color the drawing and trace the word

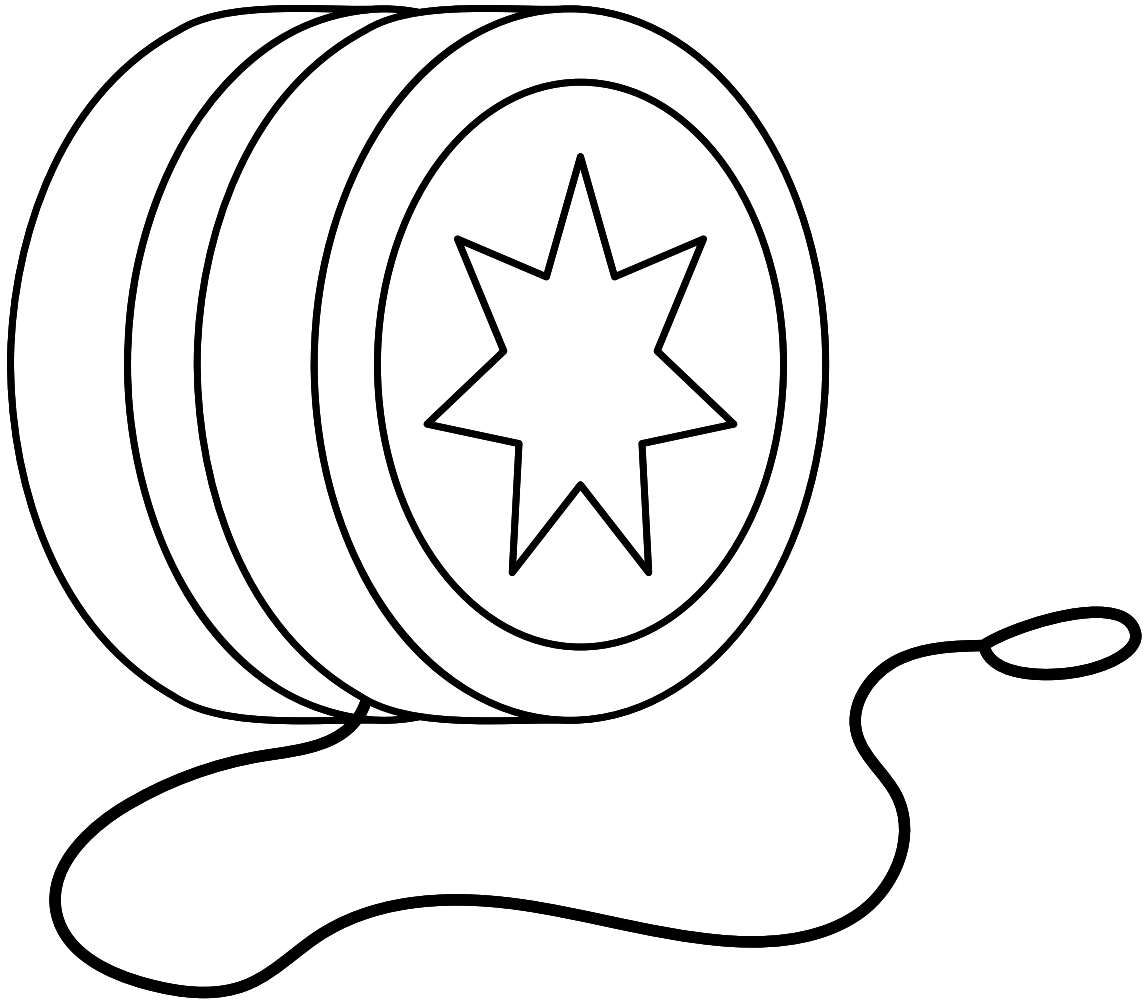

Yoyo

Color the drawing and trace the word

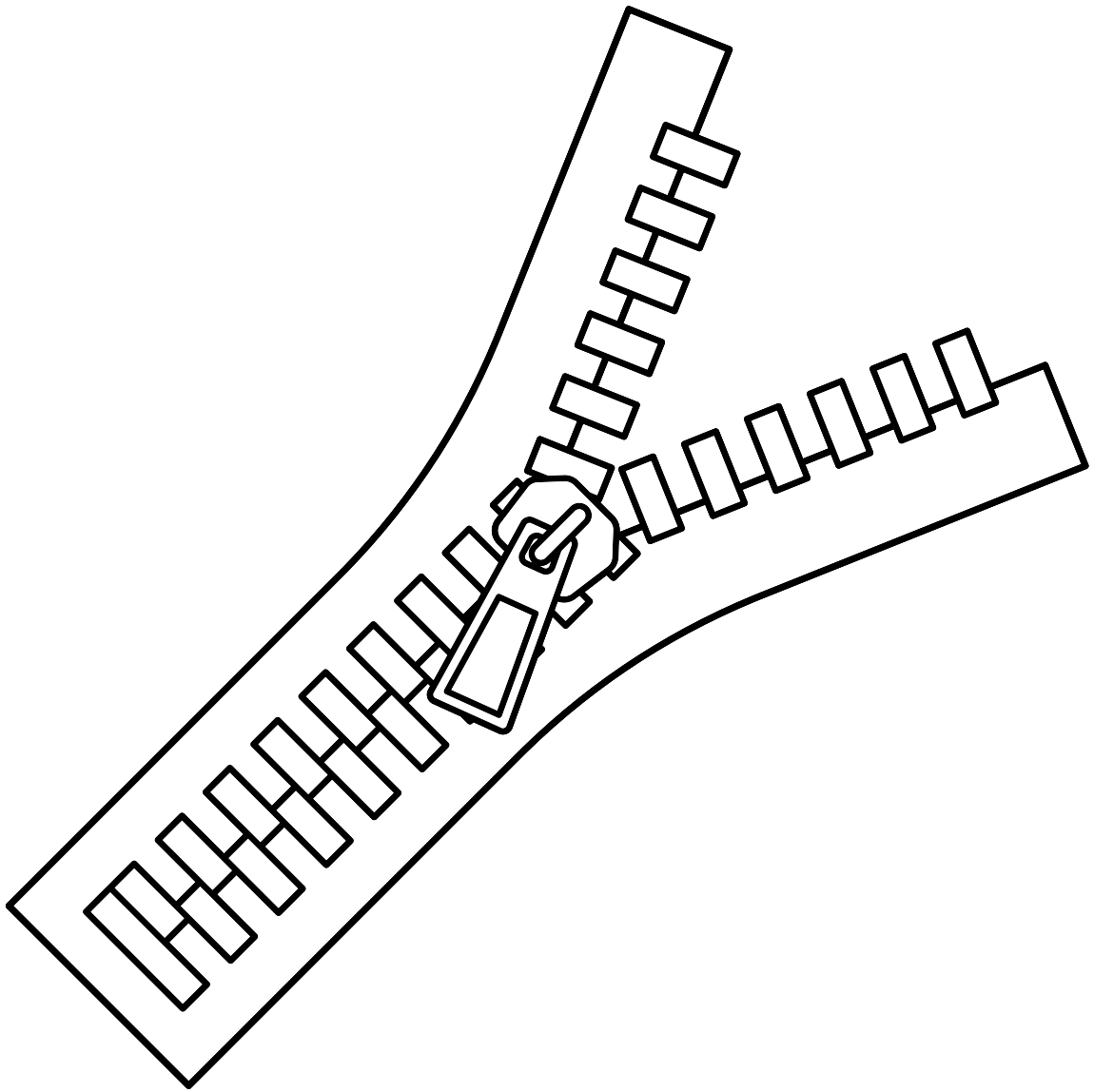

zipper