

Name : _____

I Know My Letter

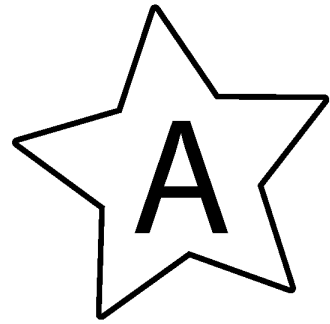

(Color the pictures)

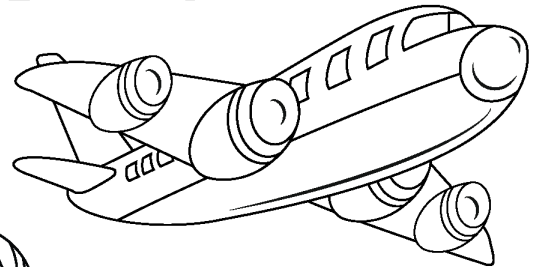
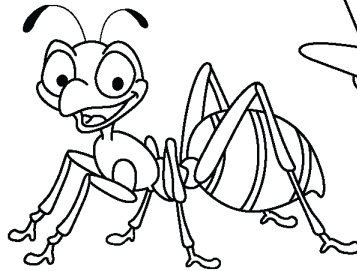
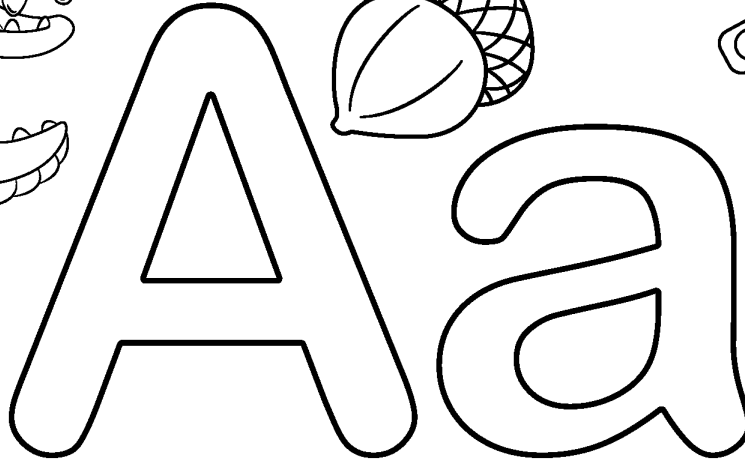
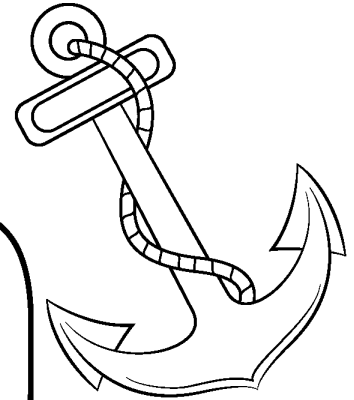
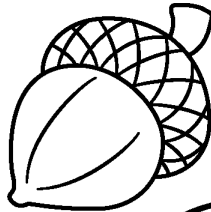
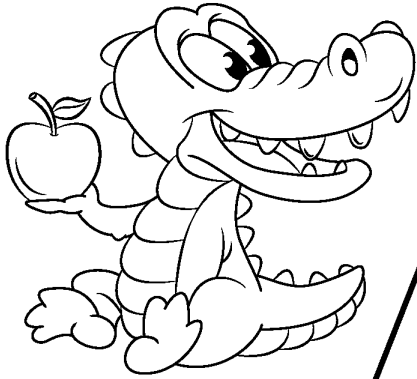

(Trace the letter A)



Name : _____

I Know My Letter

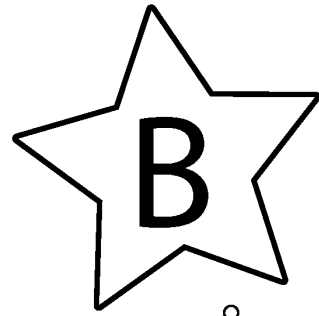

(Color the pictures)

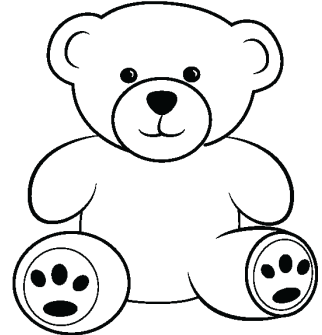
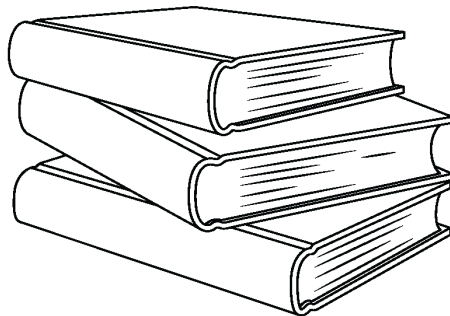
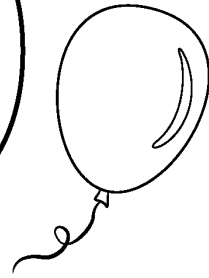
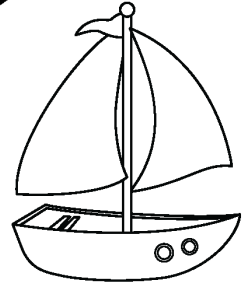
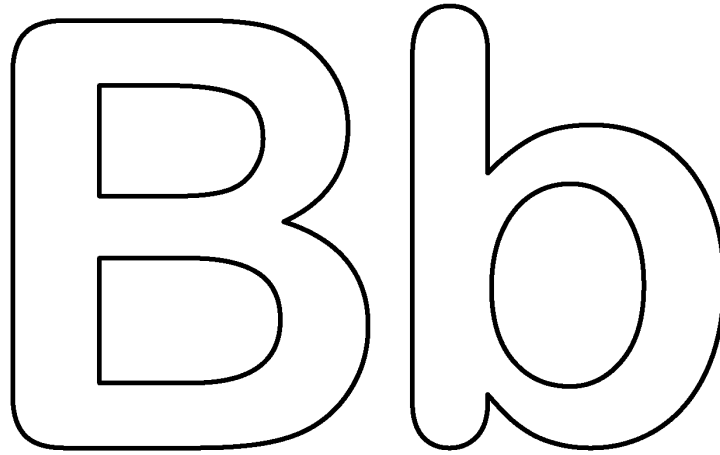
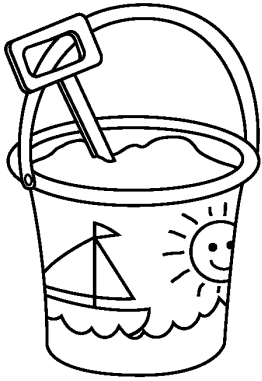

(Trace the letter B)

Bb

Bb

Bb

Bb

Bb

Bb

Bb

Bb

Name : _____

I Know My Letter

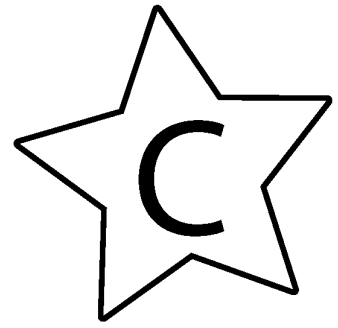

(Color the pictures)

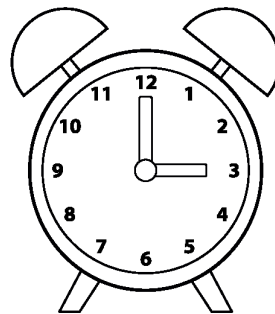
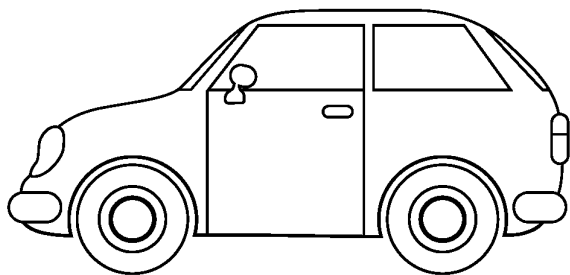
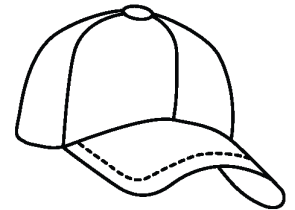
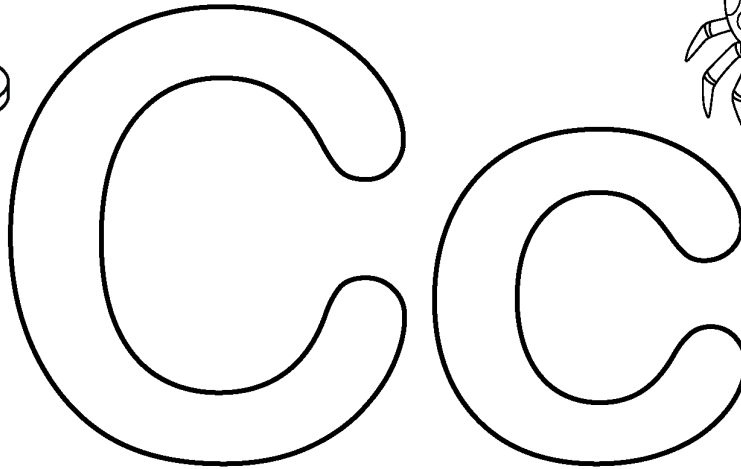
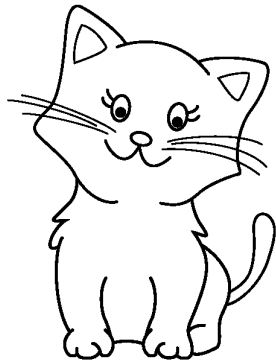
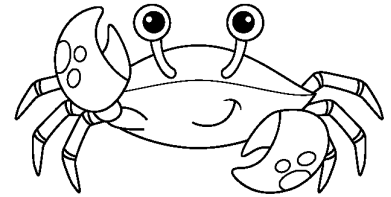

(Trace the letter C)

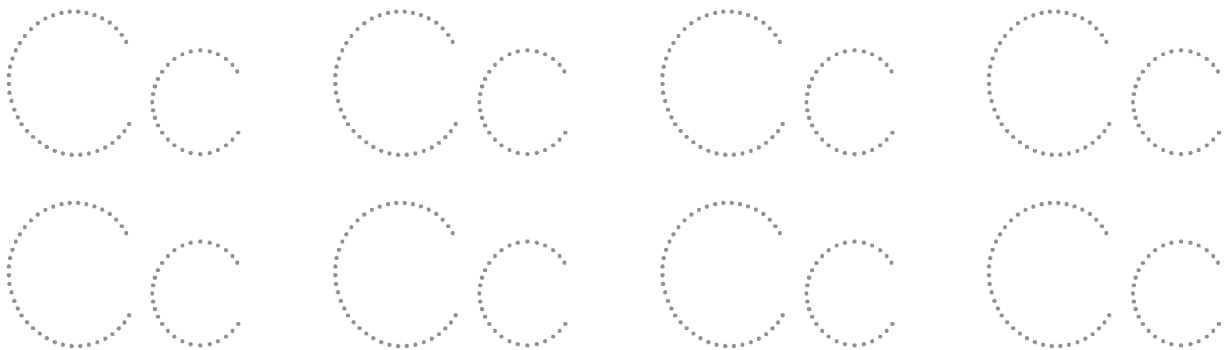

Name : _____

I Know My Letter

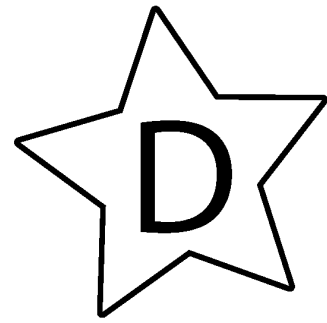

(Color the pictures)

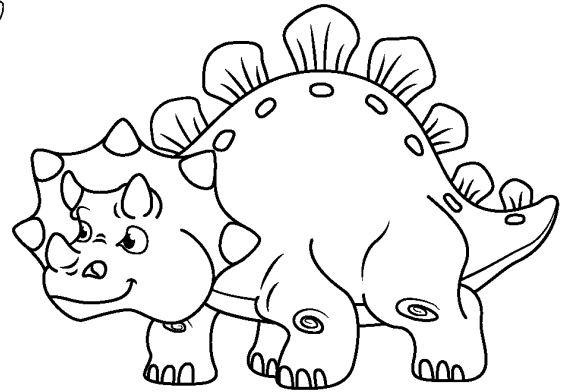
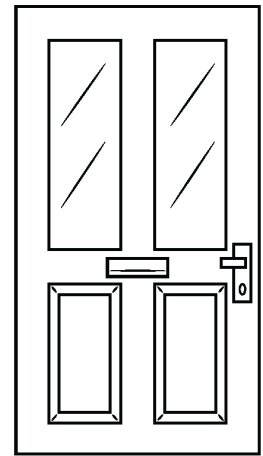
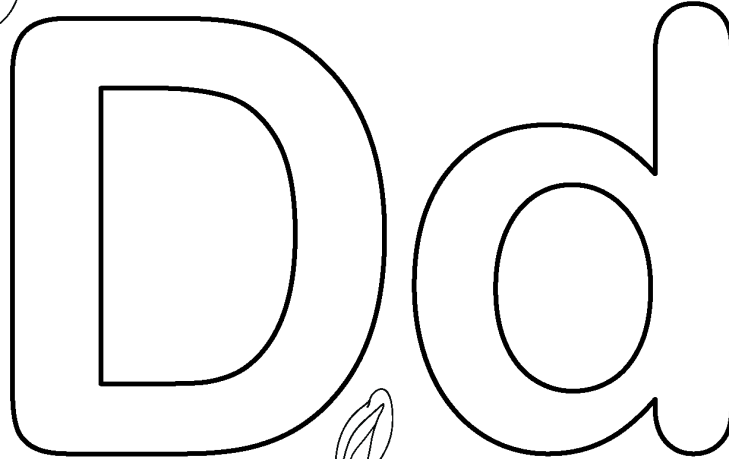
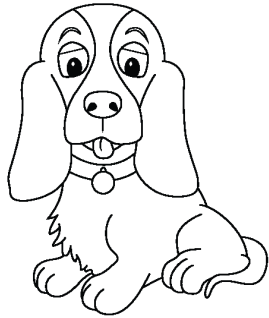
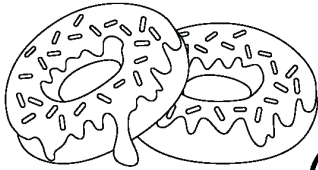

(Trace the letter D)



Name : _____

I Know My Letter

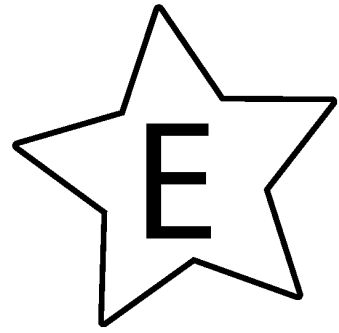

(Color the pictures)

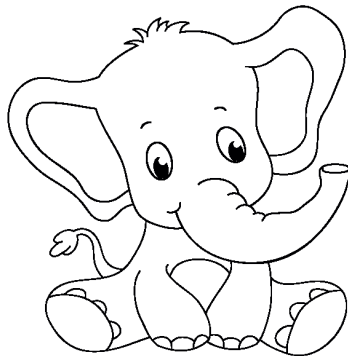
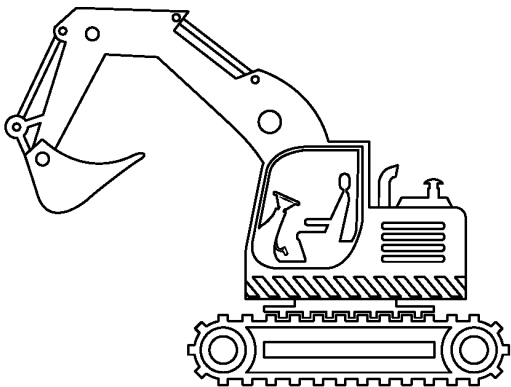
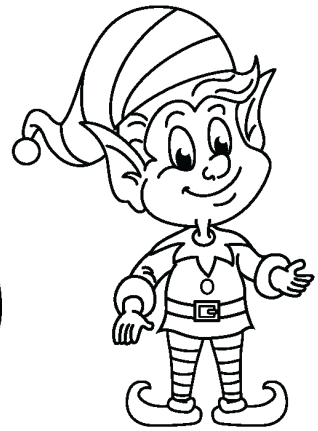
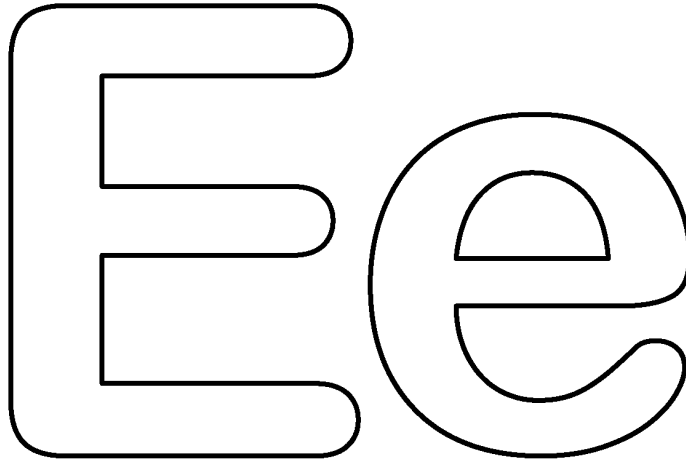
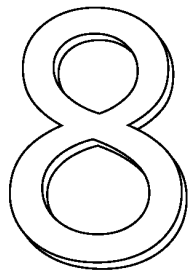
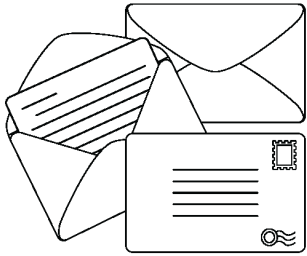

(Trace the letter E)

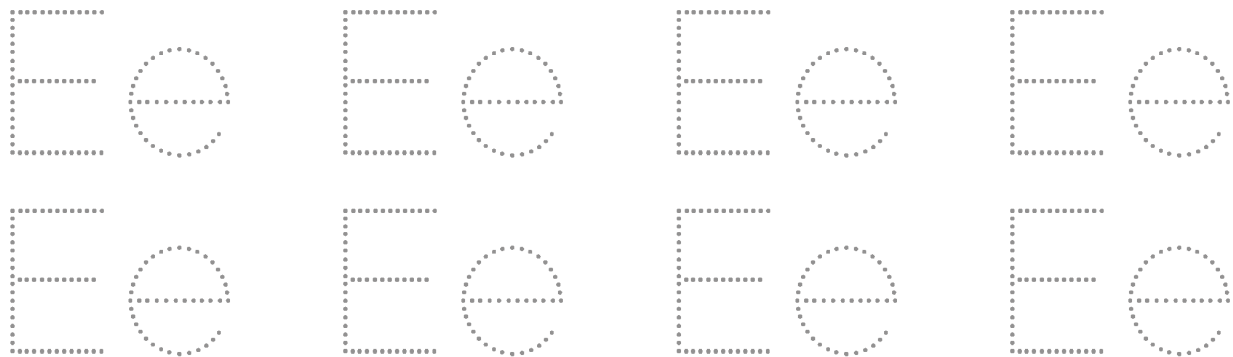

Name : _____

I Know My Letter

(Color the pictures)

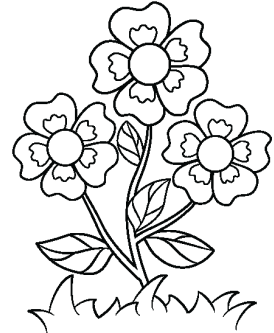
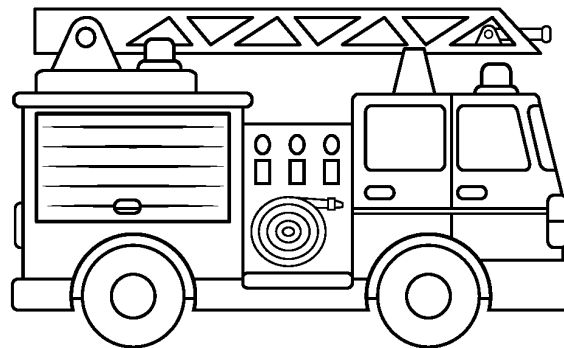
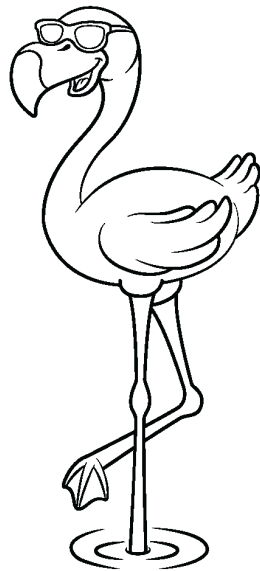
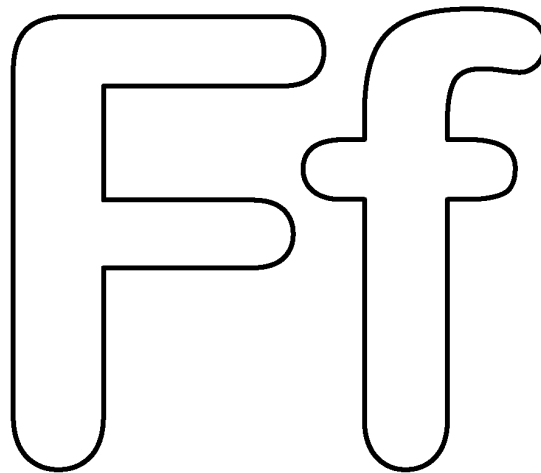
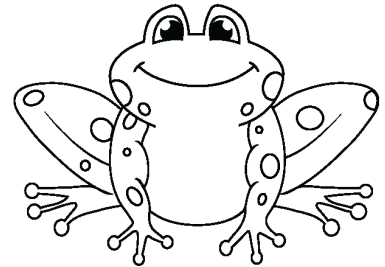
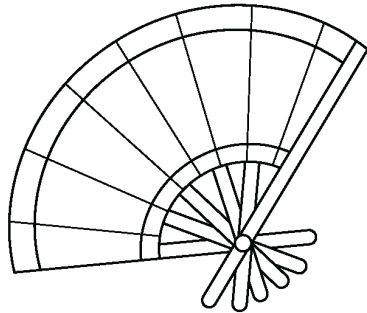
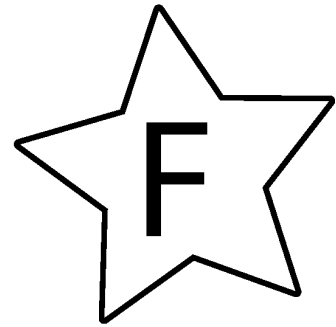

(Trace the letter F)

Ff

Ff

Ff

Ff

Ff

Ff

Ff

Ff

Name : _____

I Know My Letter



(Color the pictures)

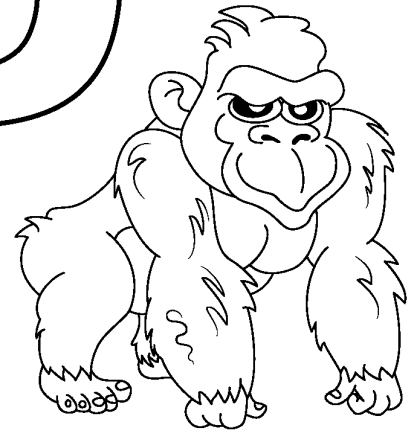
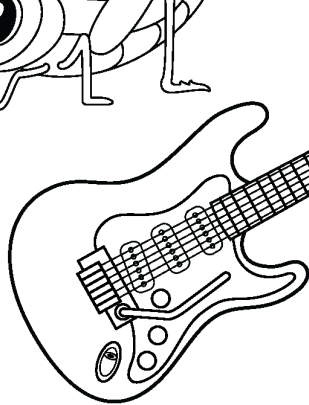
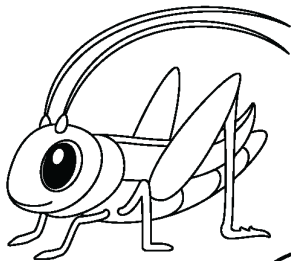
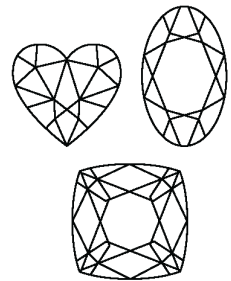
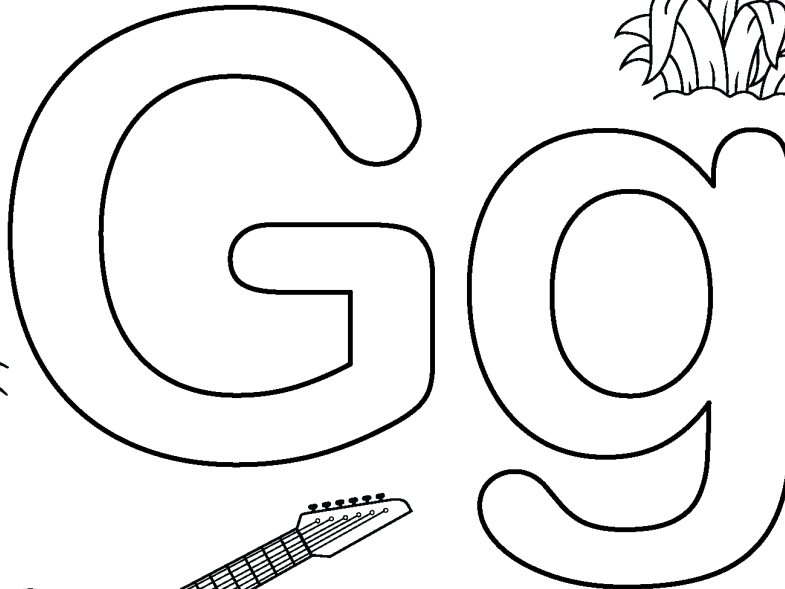
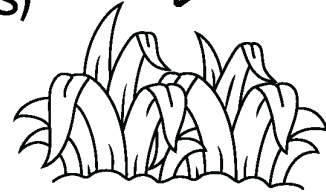

(Trace the letter G)



Name : _____

I Know My Letter

(Color the pictures)

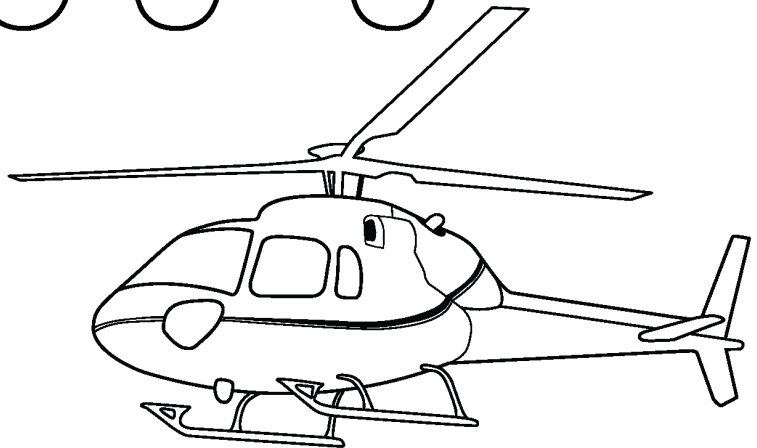
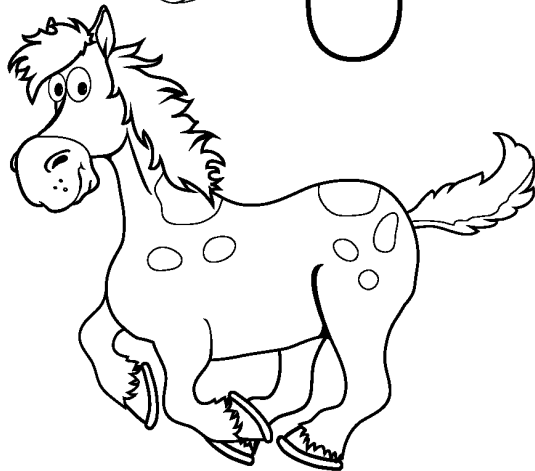
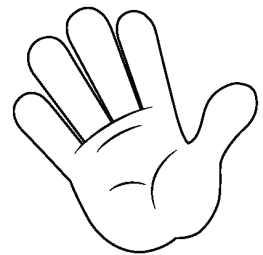
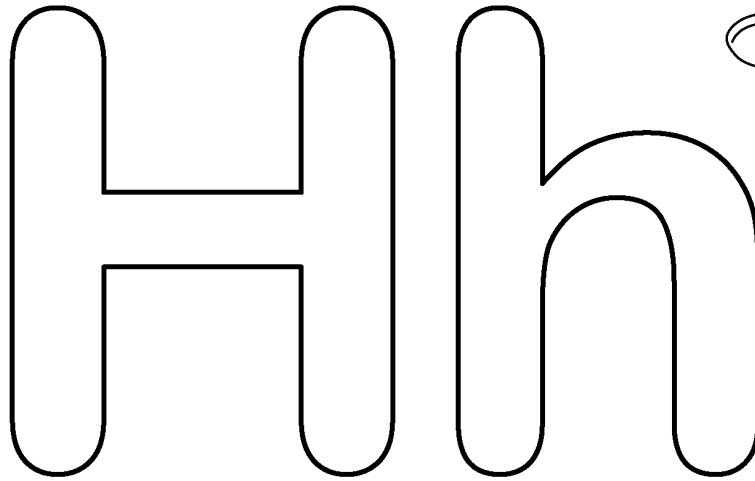
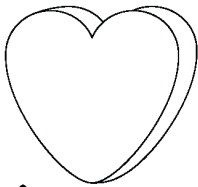
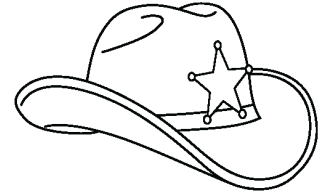
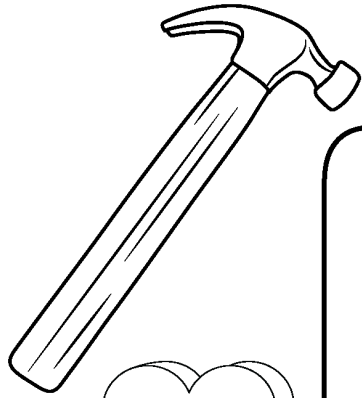
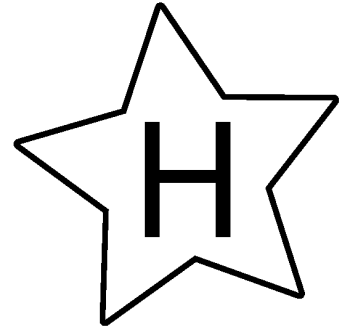

(Trace the letter H)

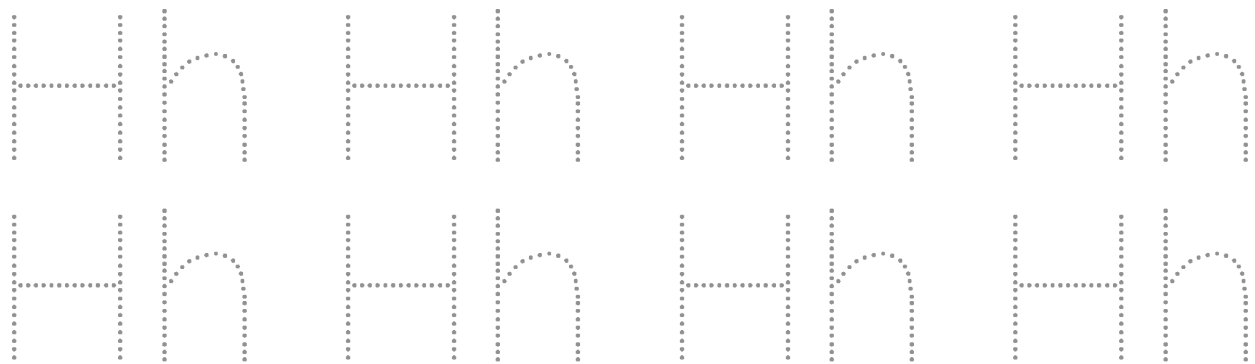

Name : _____

I Know My Letter

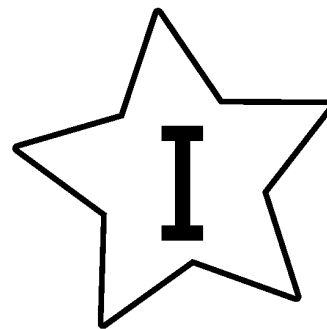

(Color the pictures)

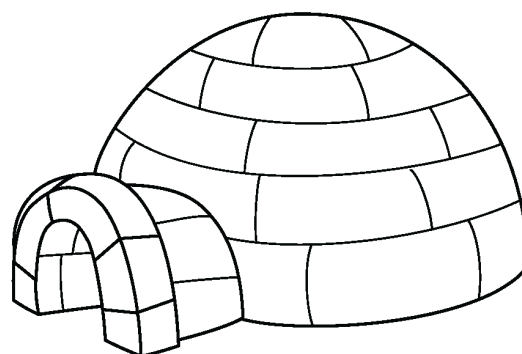
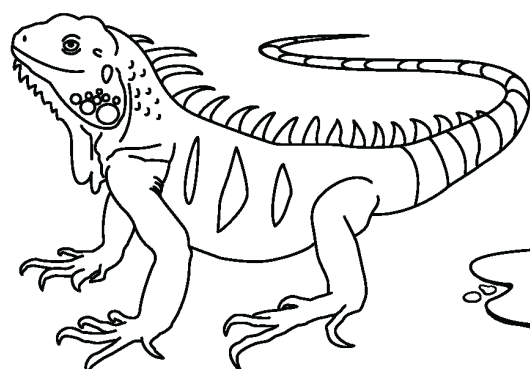
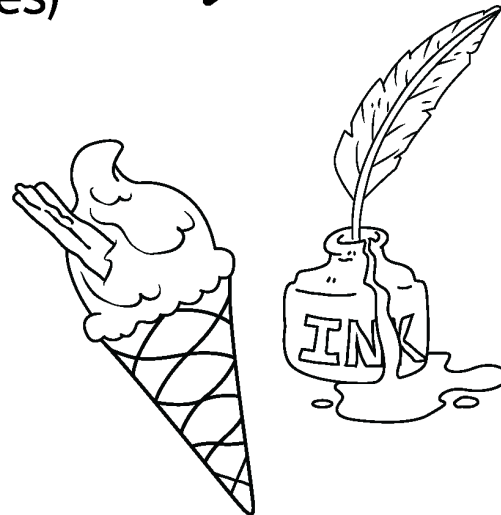
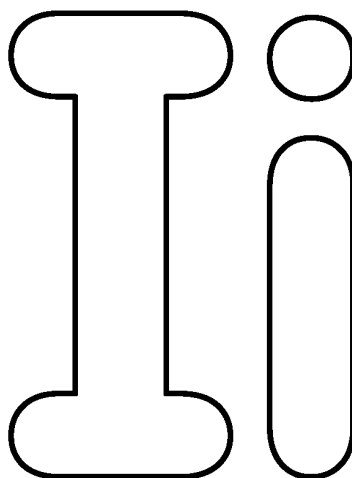
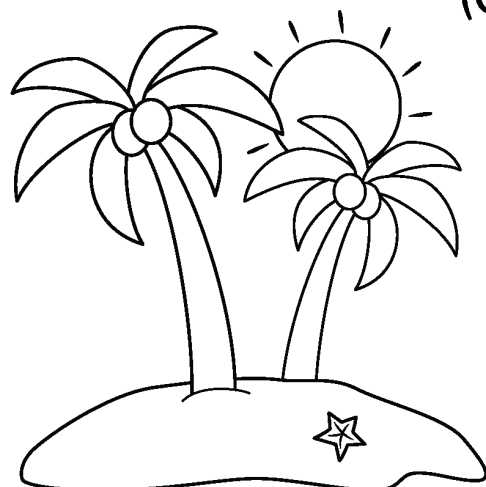

(Trace the letter I)

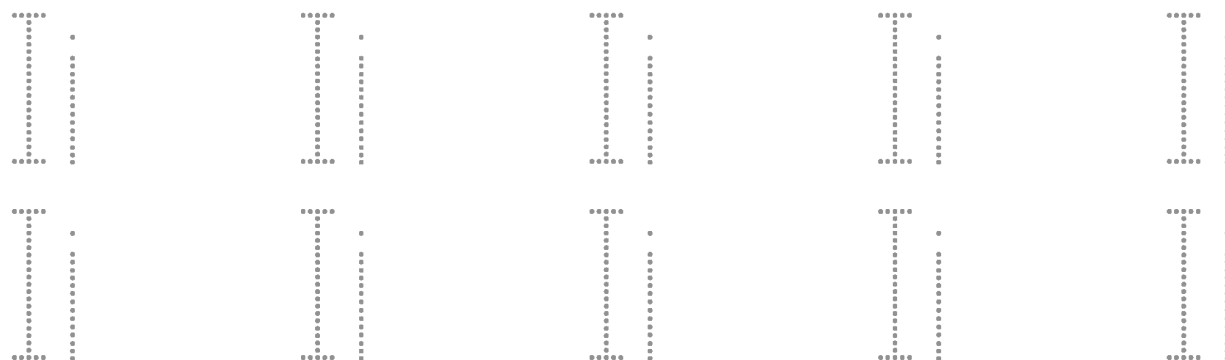

Name : _____

I Know My Letter

(Color the pictures)

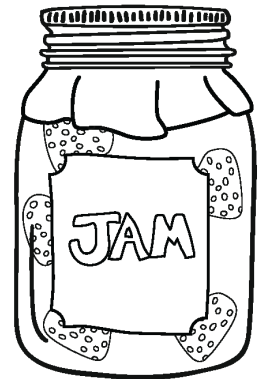
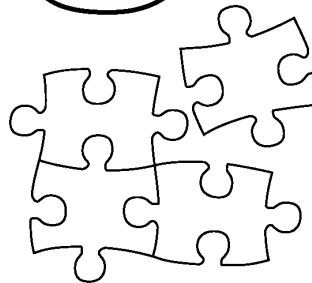
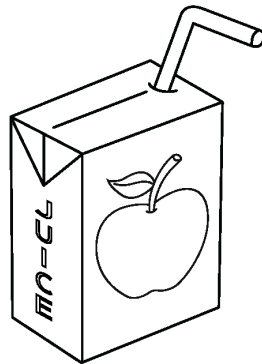
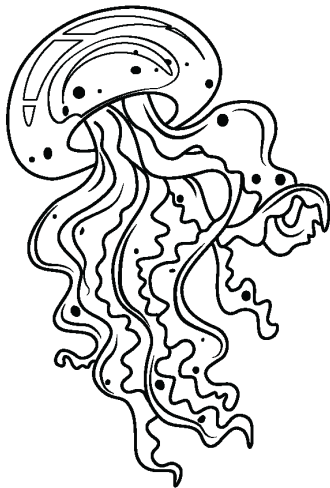
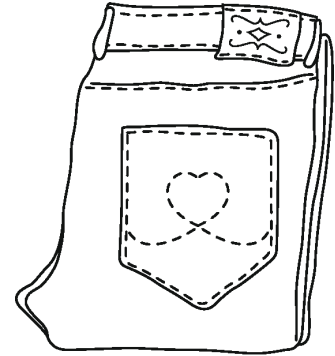
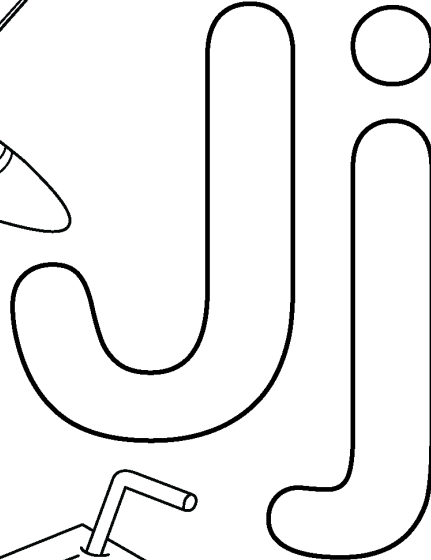
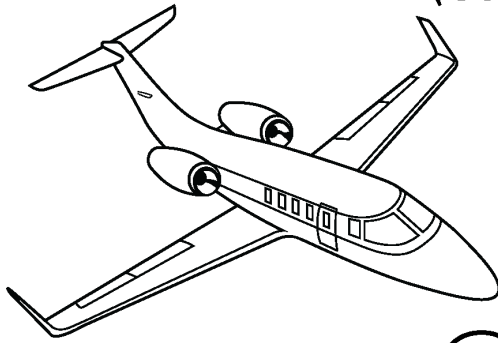
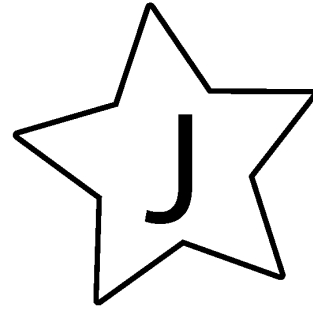

(Trace the letter J)

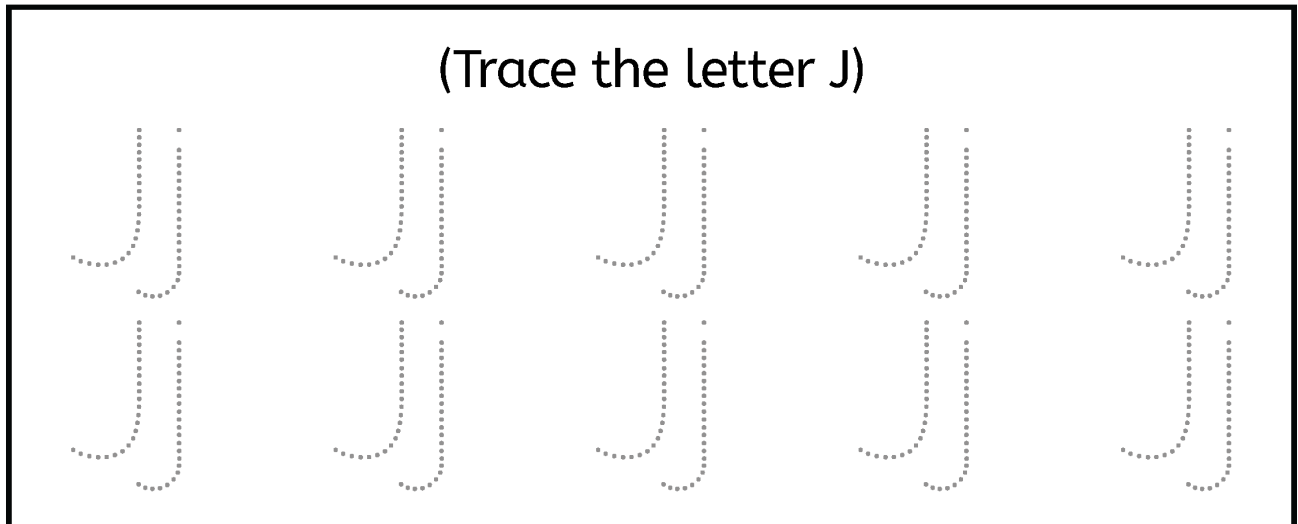

Name : _____

I Know My Letter

(Color the pictures)

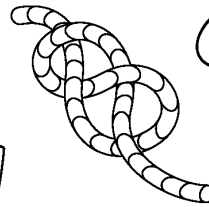
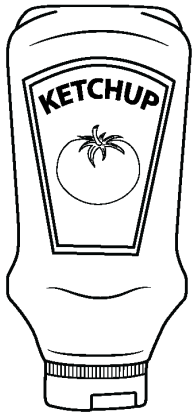
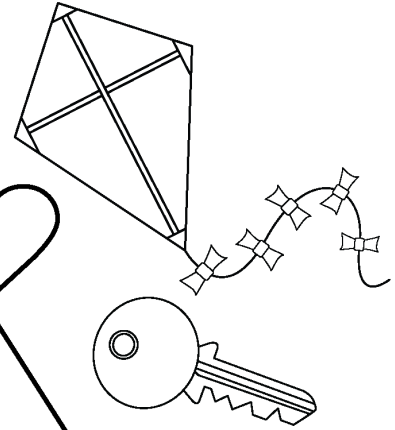
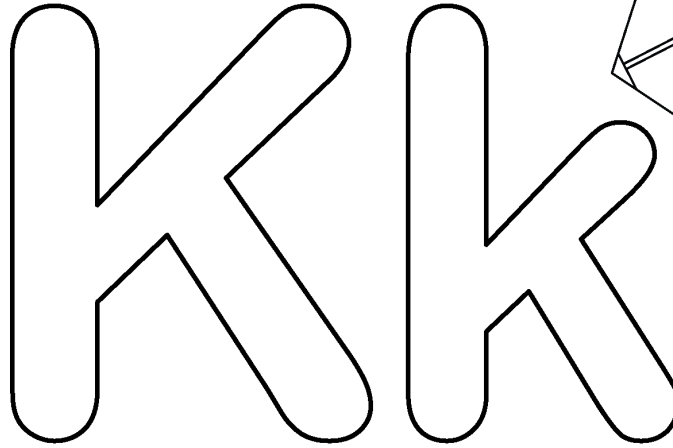
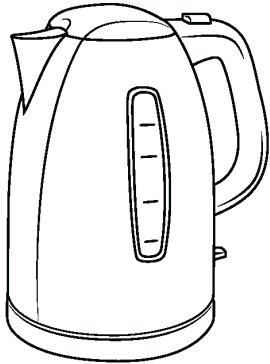
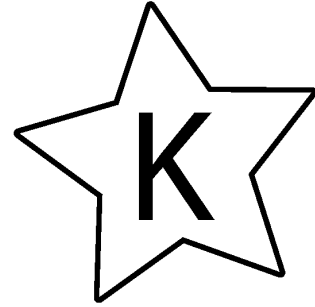

(Trace the letter K)



Name : _____

I Know My Letter

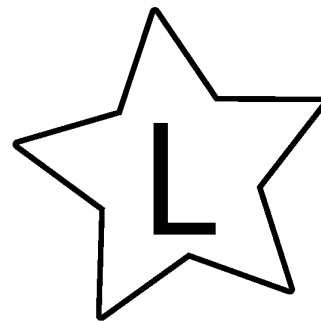

(Color the pictures)

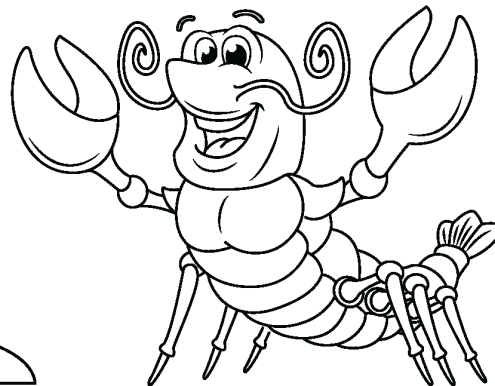
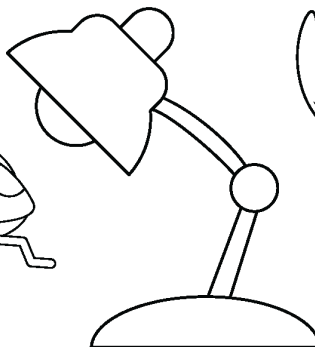
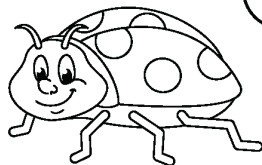
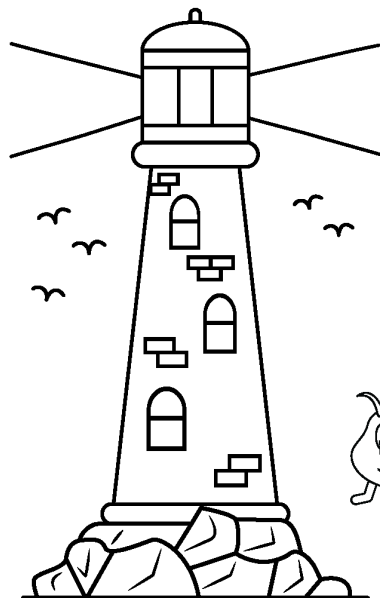
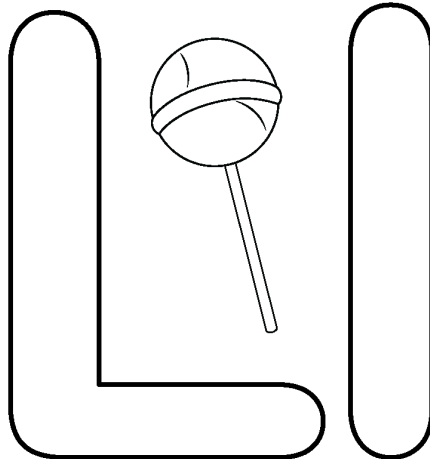
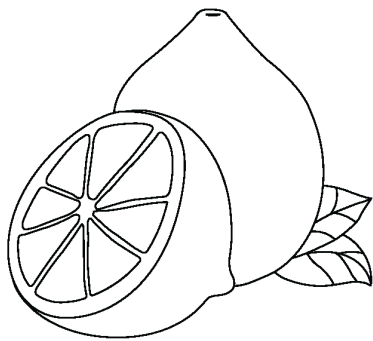

(Trace the letter L)

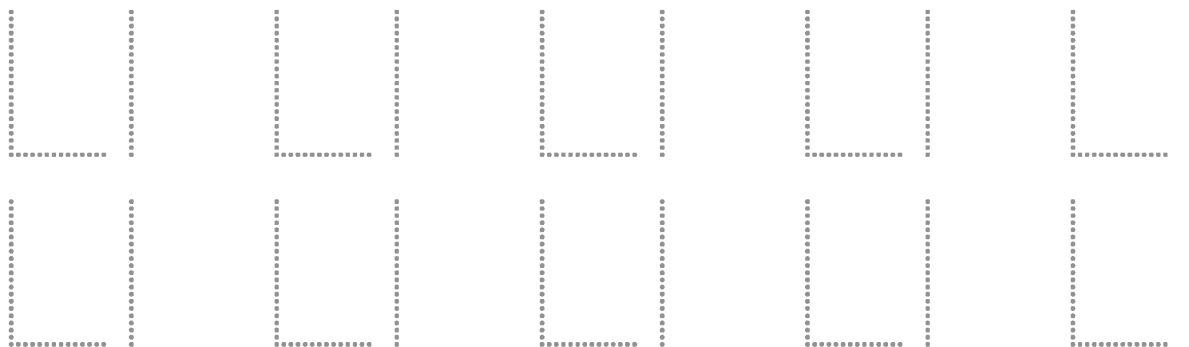

Name : _____

I Know My Letter

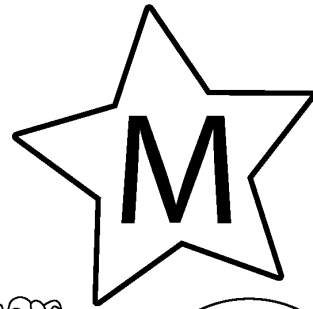

(Color the pictures)

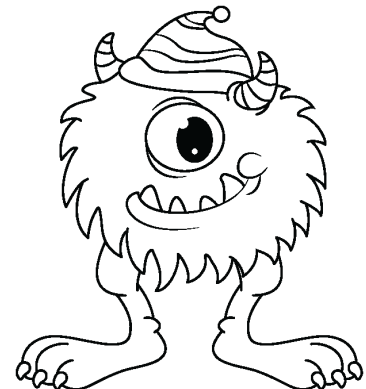
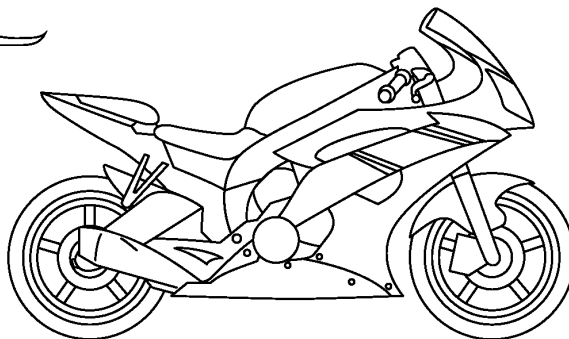
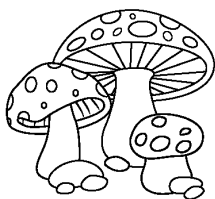
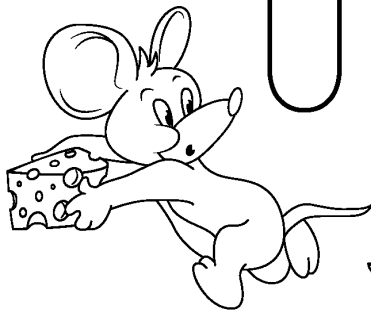
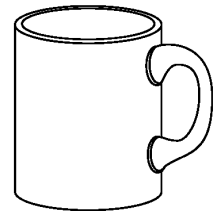
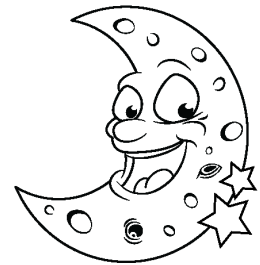

(Trace the letter M)



Name : _____

I Know My Letter

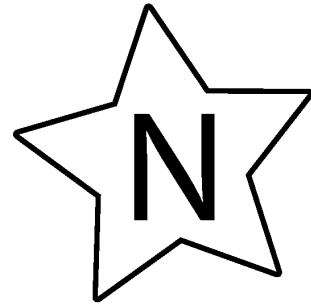

(Color the pictures)

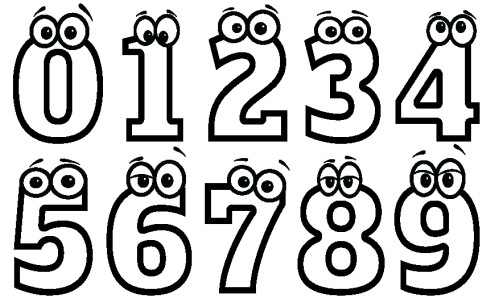
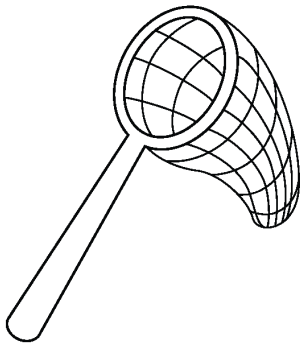
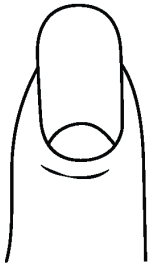
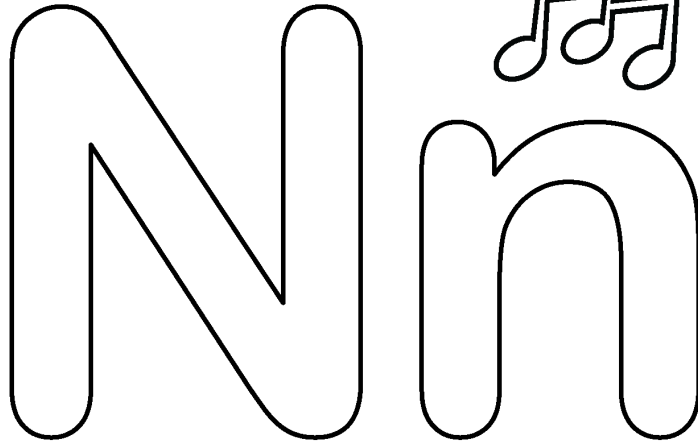
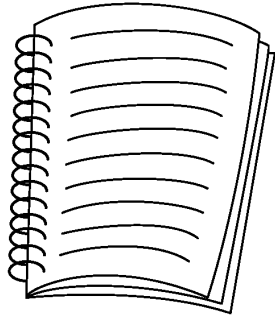

(Trace the letter N)



Name : _____

I Know My Letter

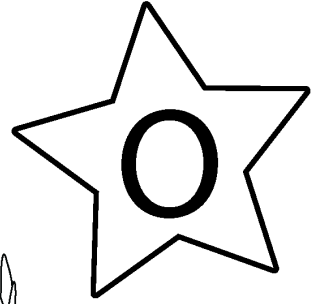

(Color the pictures)

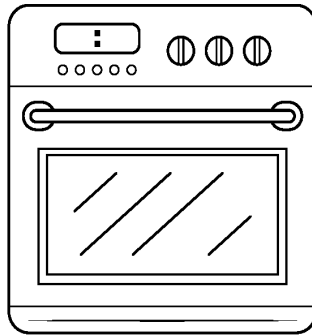
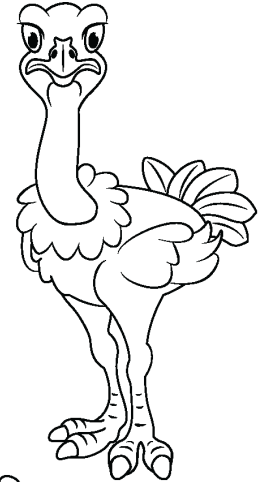
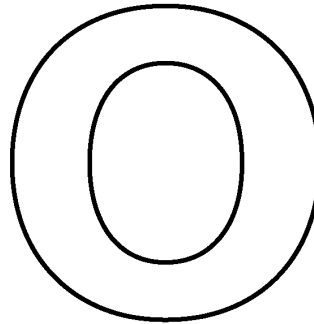
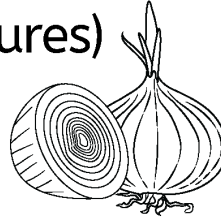
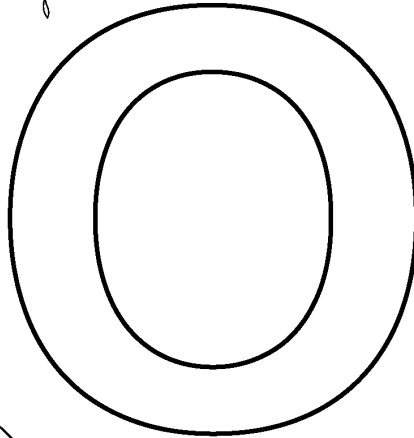

(Trace the letter O)

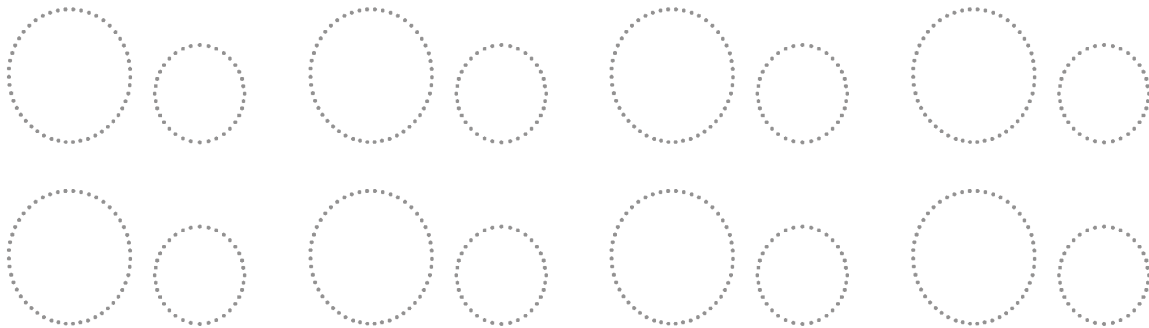

Name : _____

I Know My Letter

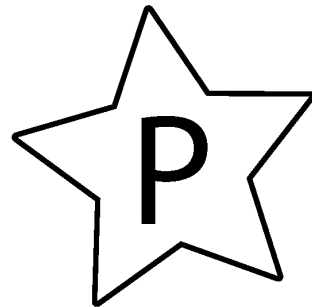

(Color the pictures)

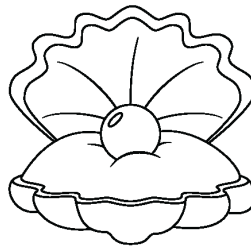
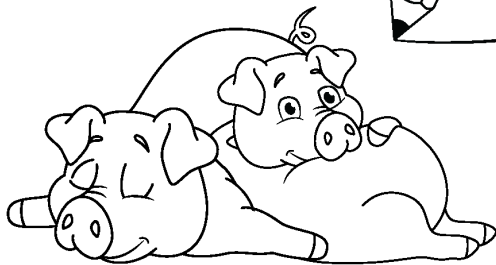
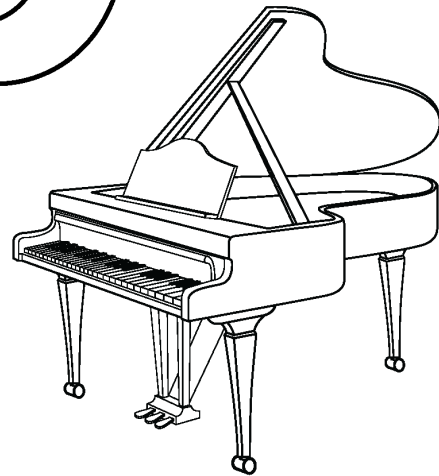
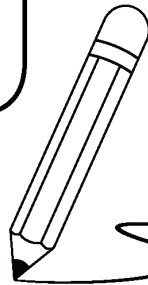
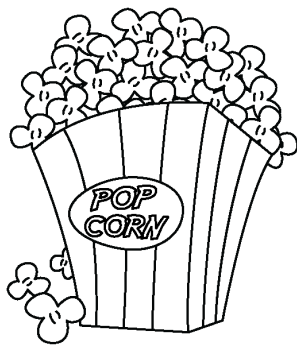
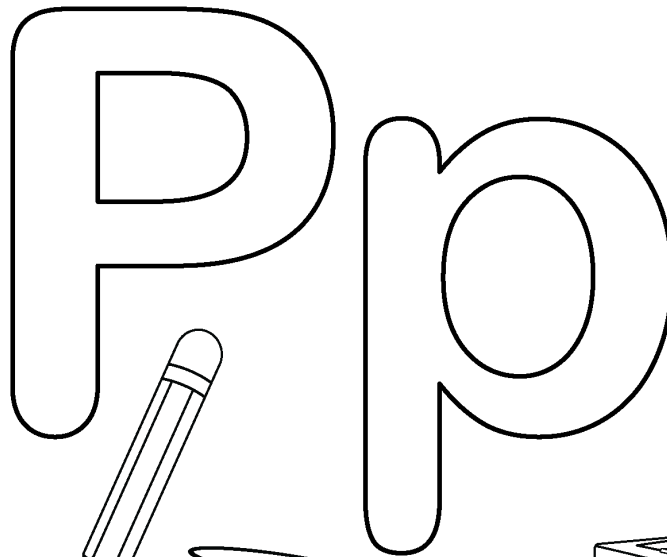
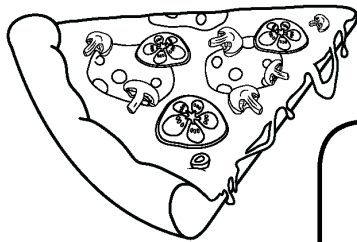

(Trace the letter P)

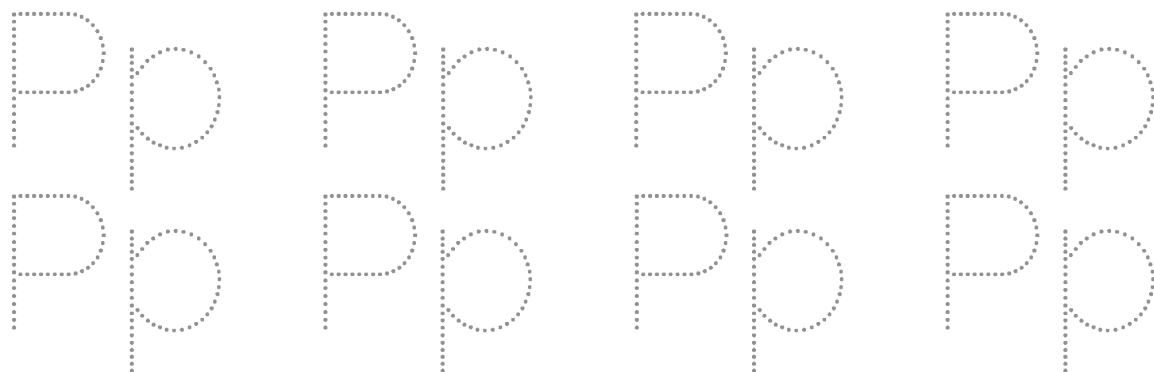

Name : _____

I Know My Letter

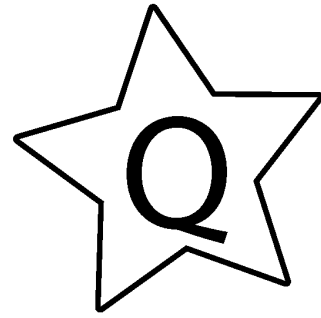

(Color the pictures)

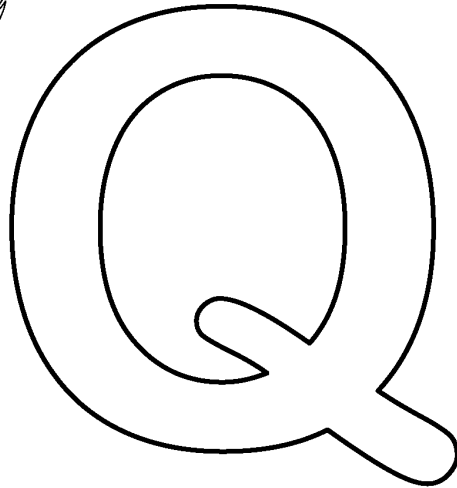
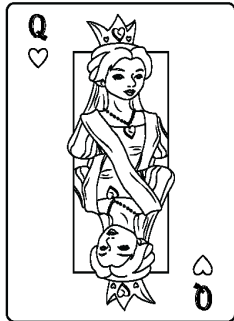

QUICK

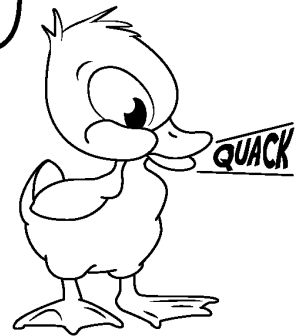
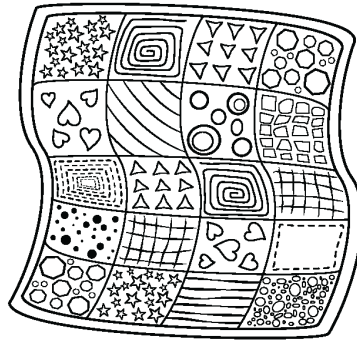
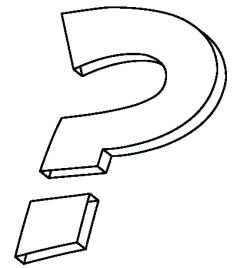
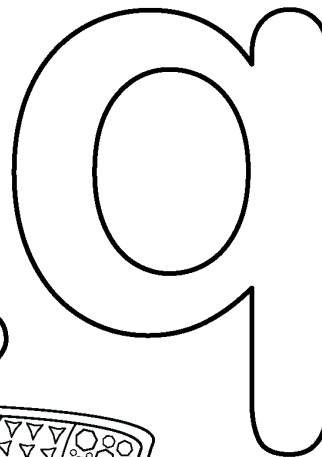

(Trace the letter Q)

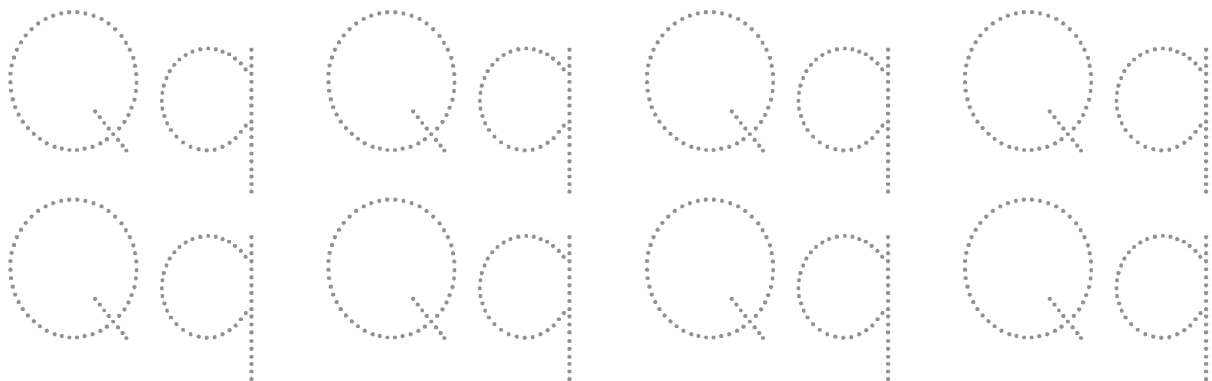

Name : _____

I Know My Letter

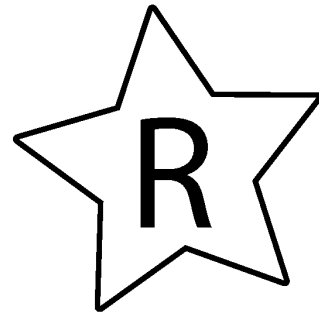

(Color the pictures)

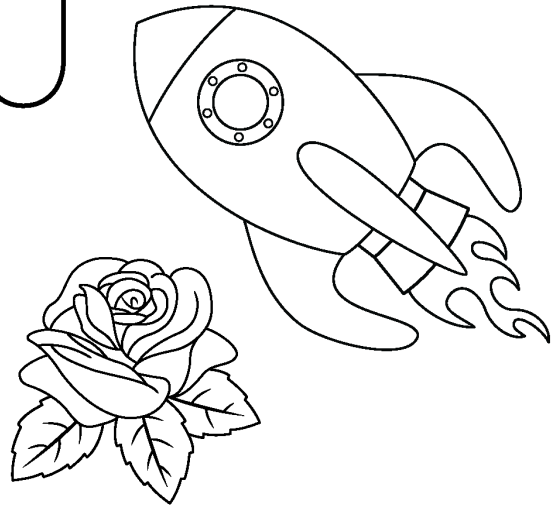
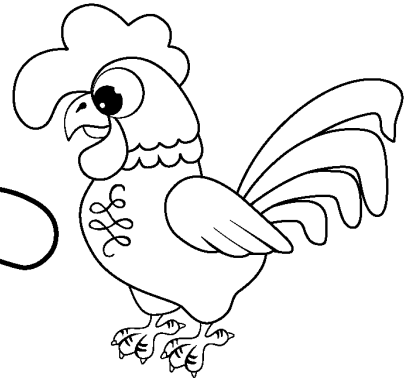
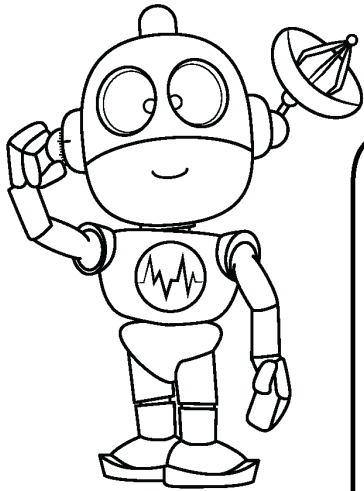

(Trace the letter R)

Rr Rr Rr Rr Rr

Rr Rr Rr Rr Rr

Name : _____

I Know My Letter

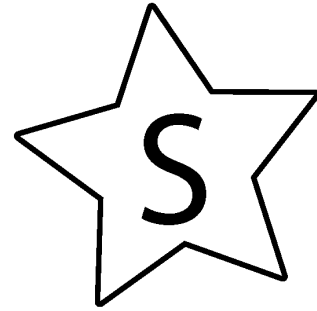

(Color the pictures)

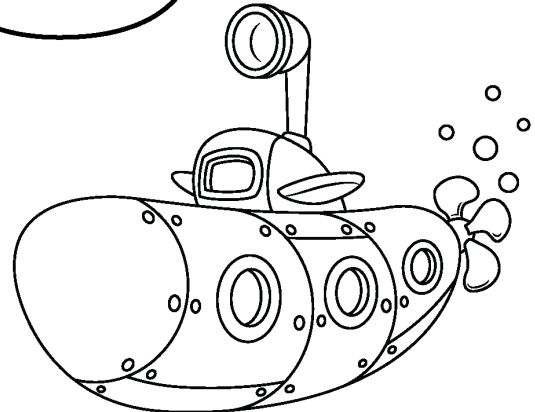
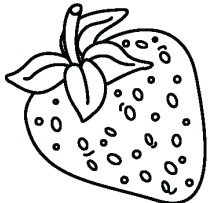
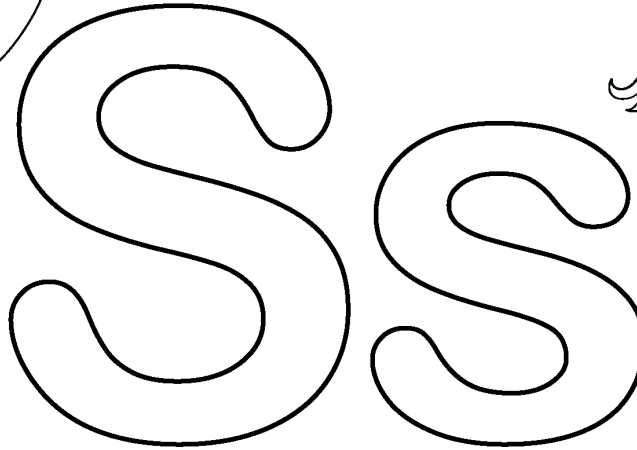
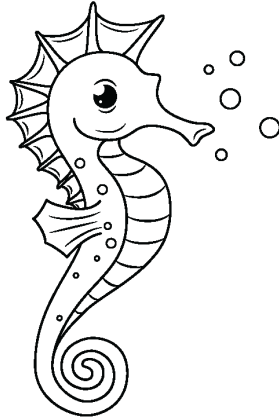
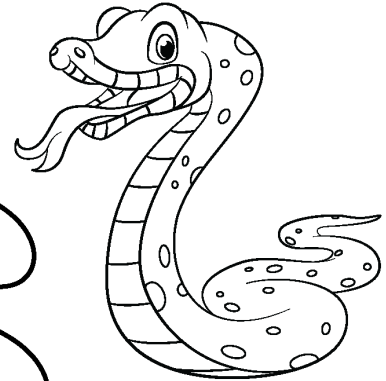
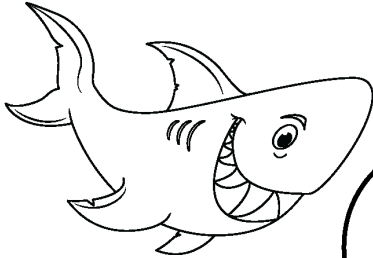

(Trace the letter S)



Name : _____

I Know My Letter

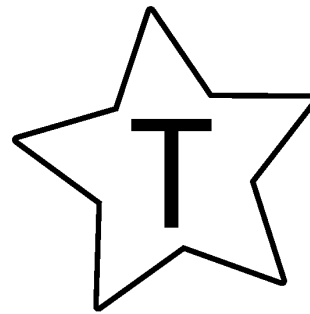

(Color the pictures)

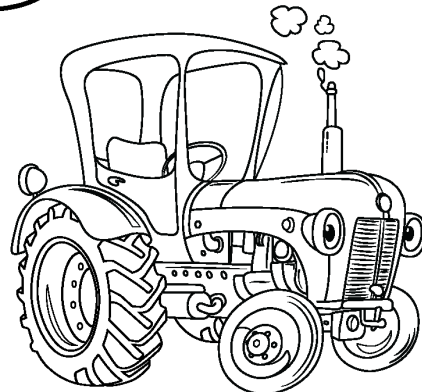
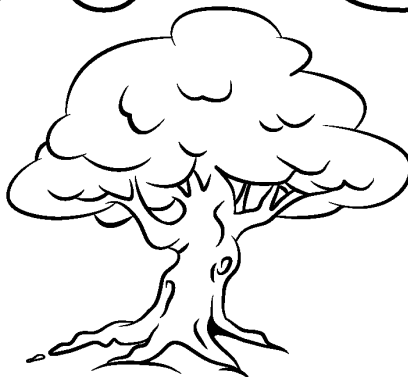
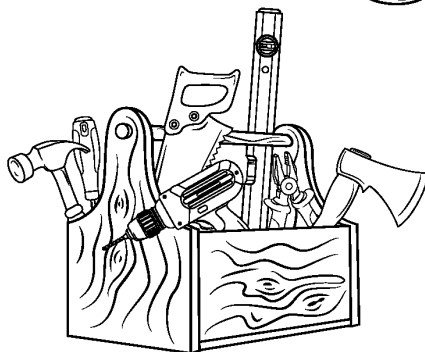
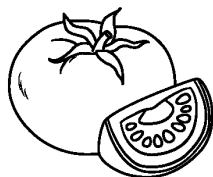
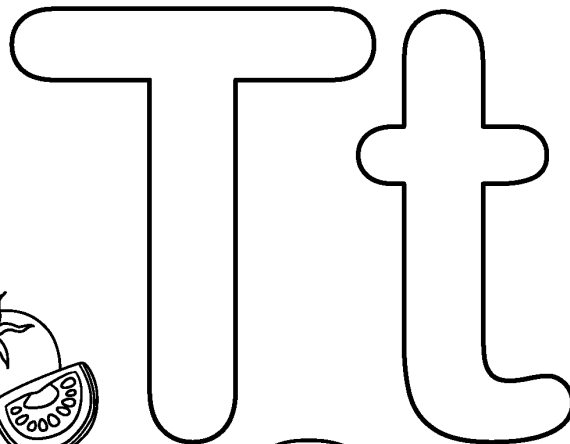
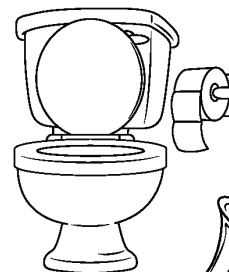
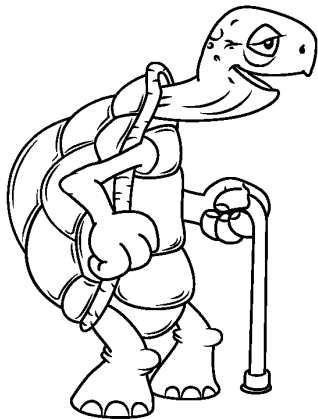

(Trace the letter T)

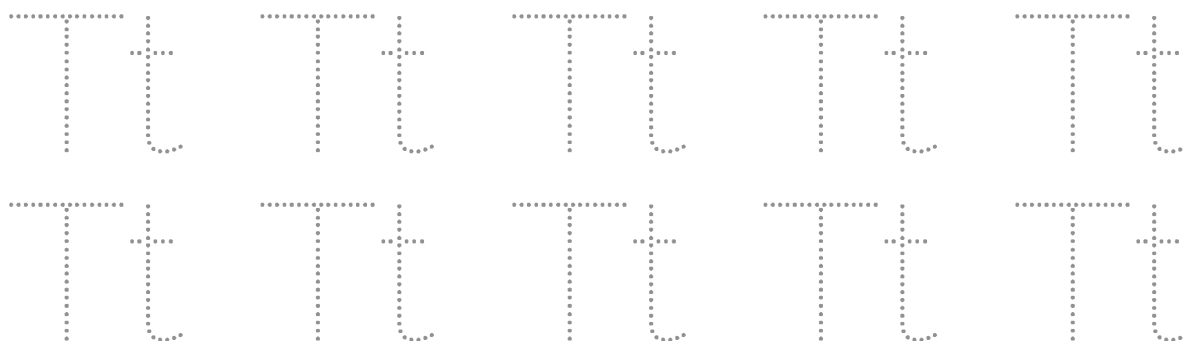

Name : _____

I Know My Letter

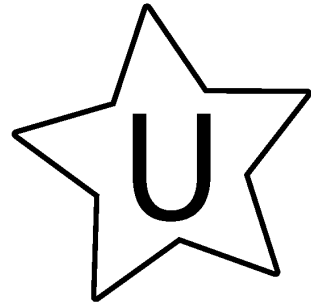

(Color the pictures)

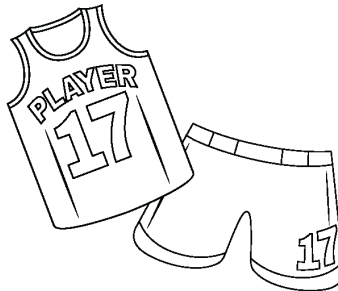
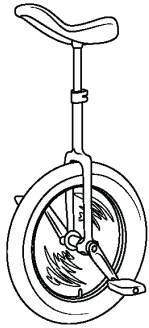
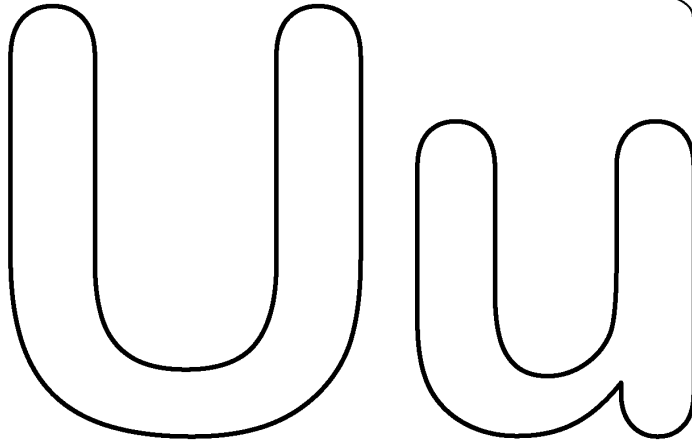
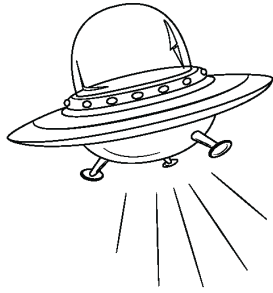

(Trace the letter U)



Name : _____

I Know My Letter

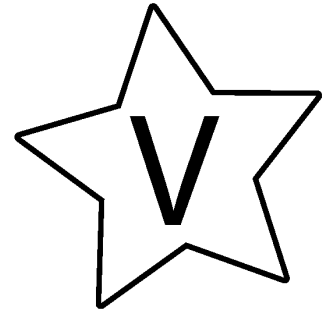

(Color the pictures)

a e
u o i

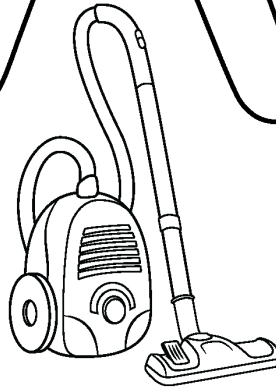
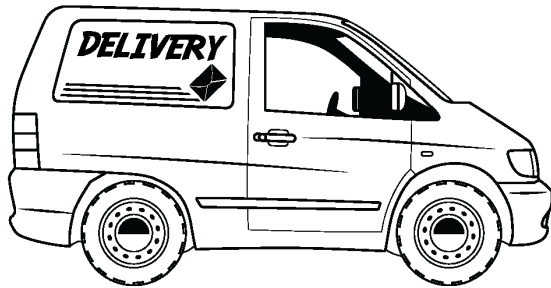
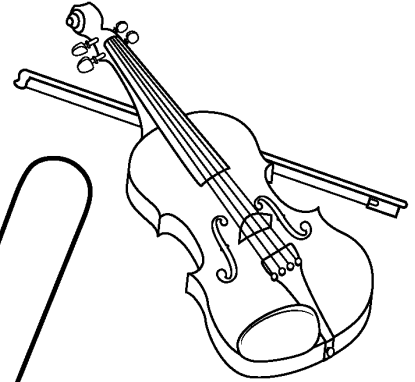
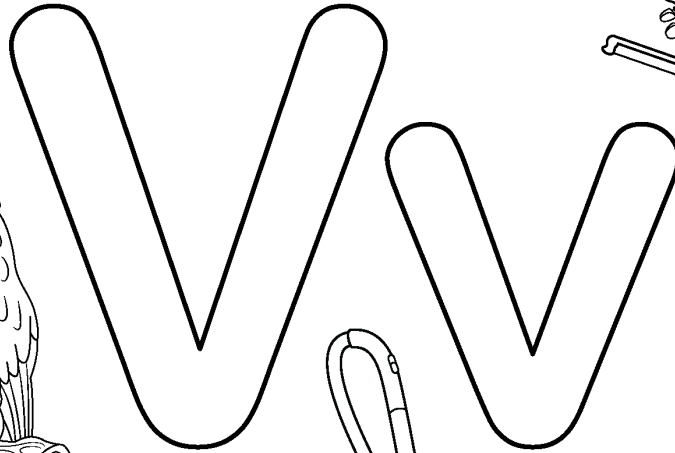

(Trace the letter V)



Name : _____

I Know My Letter



(Color the pictures)

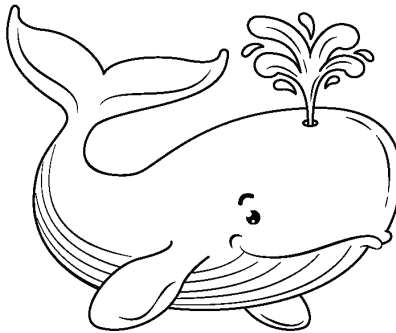
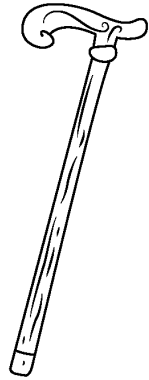
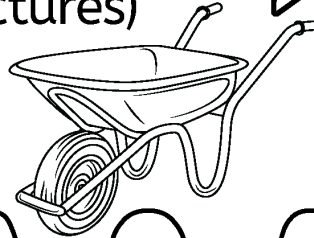
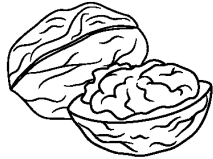

(Trace the letter W)



Name : _____

I Know My Letter

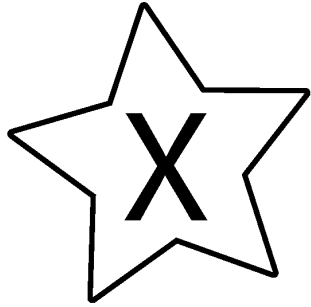

(Color the pictures)

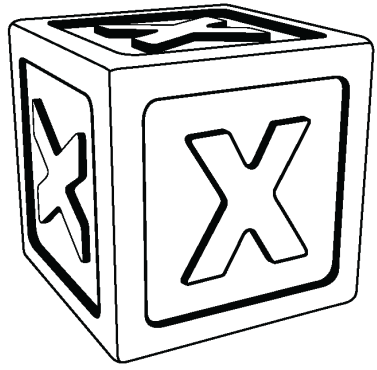
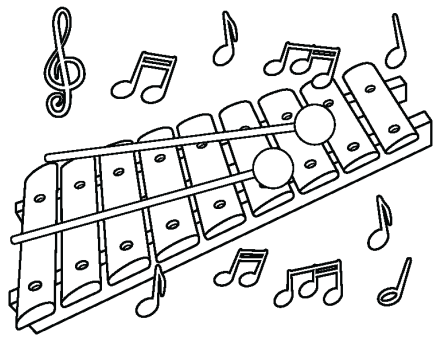
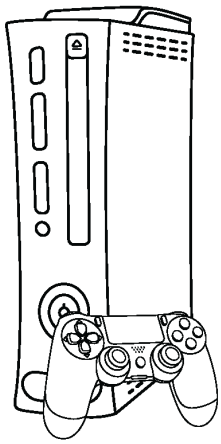
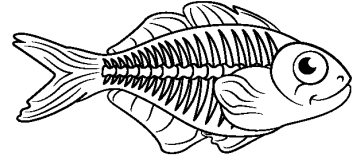
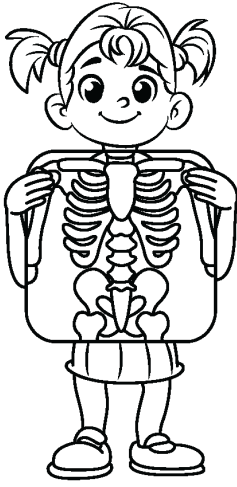

(Trace the letter X)

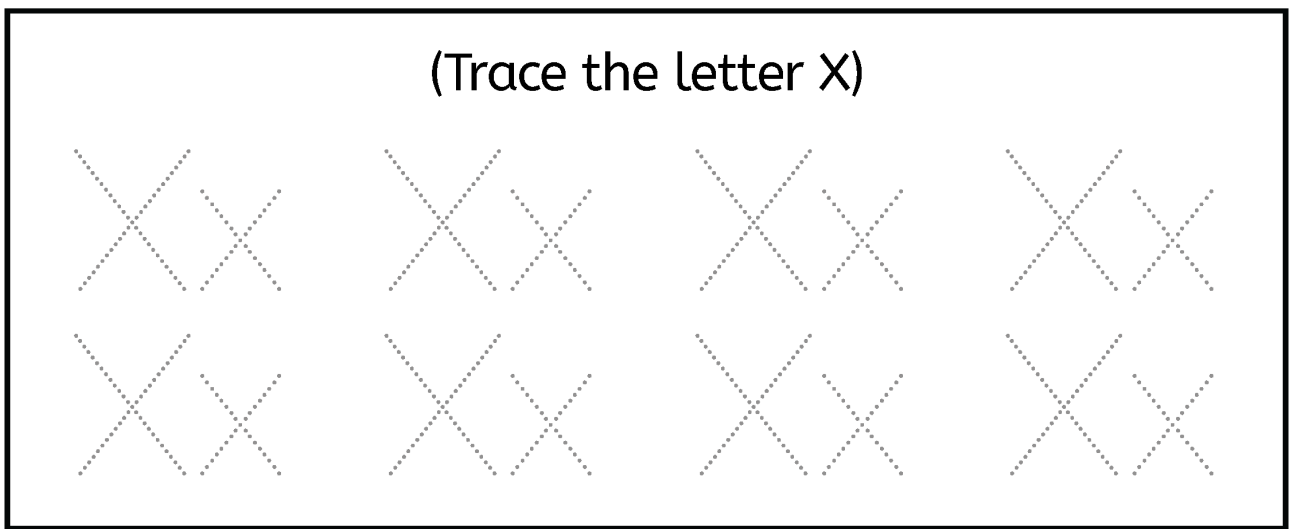

Name : _____

I Know My Letter

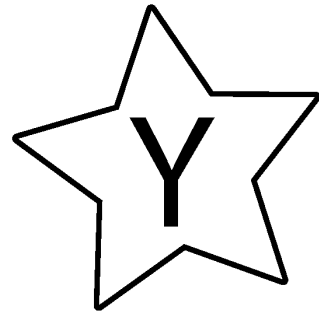

(Color the pictures)

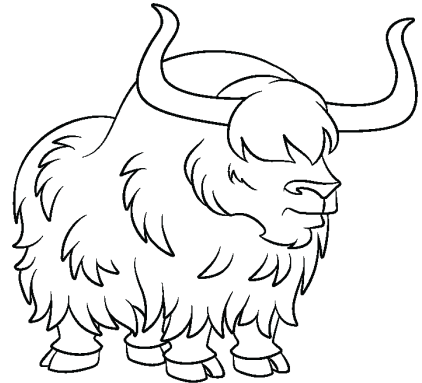
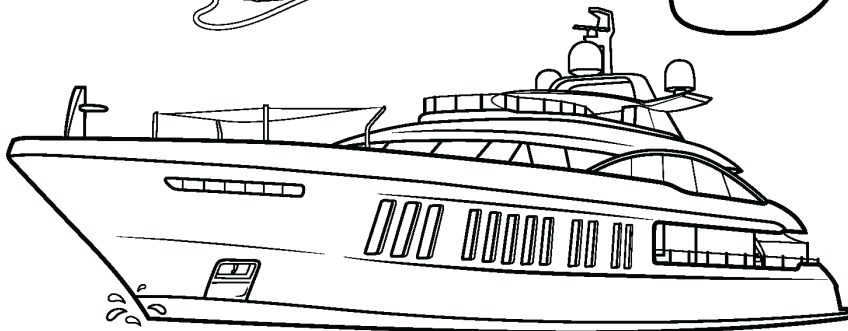
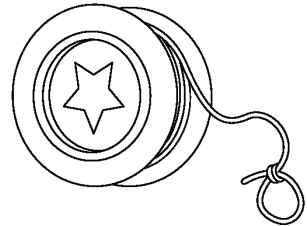
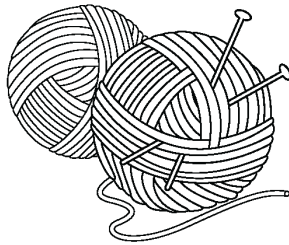
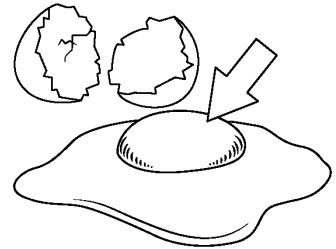
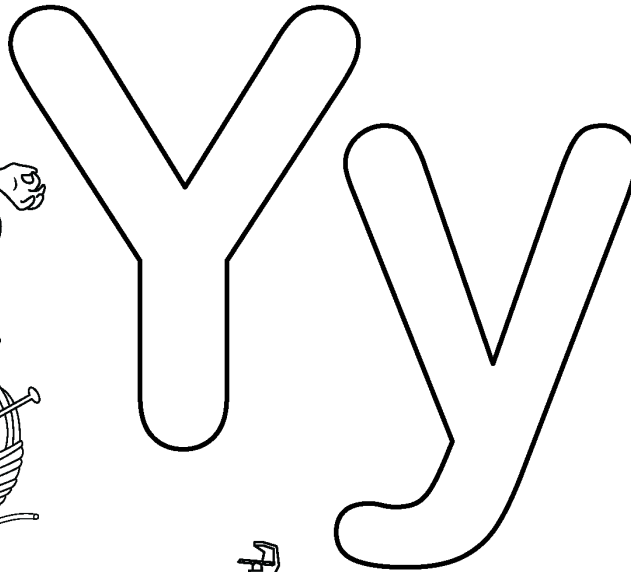

(Trace the letter Y)



Name : _____

I Know My Letter



(Color the pictures)

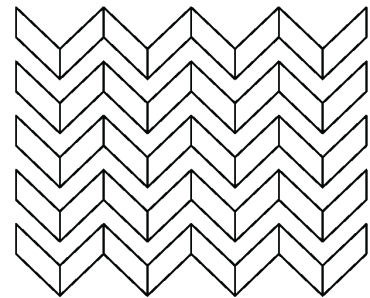
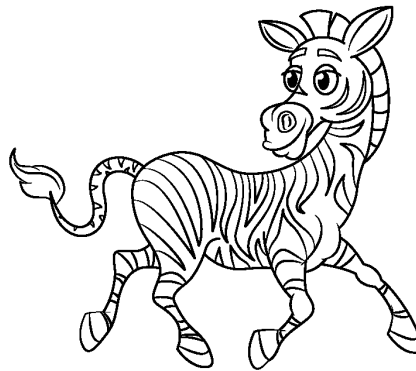
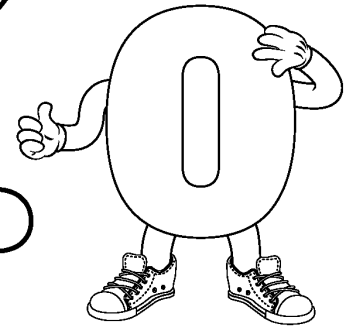
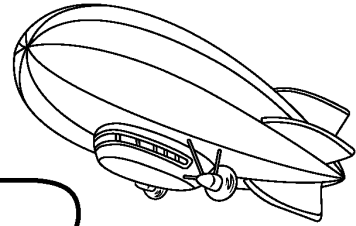
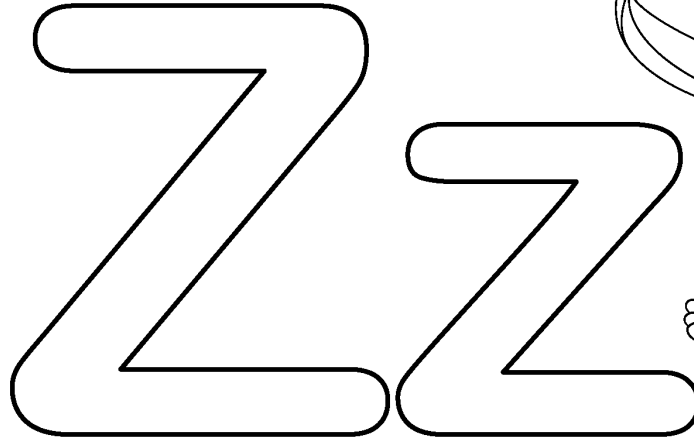
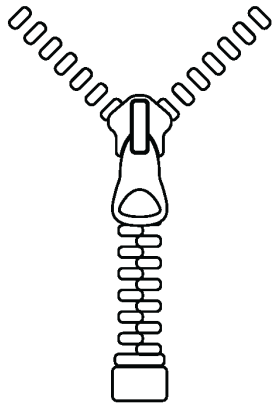

(Trace the letter Z)

