

NAME: _____

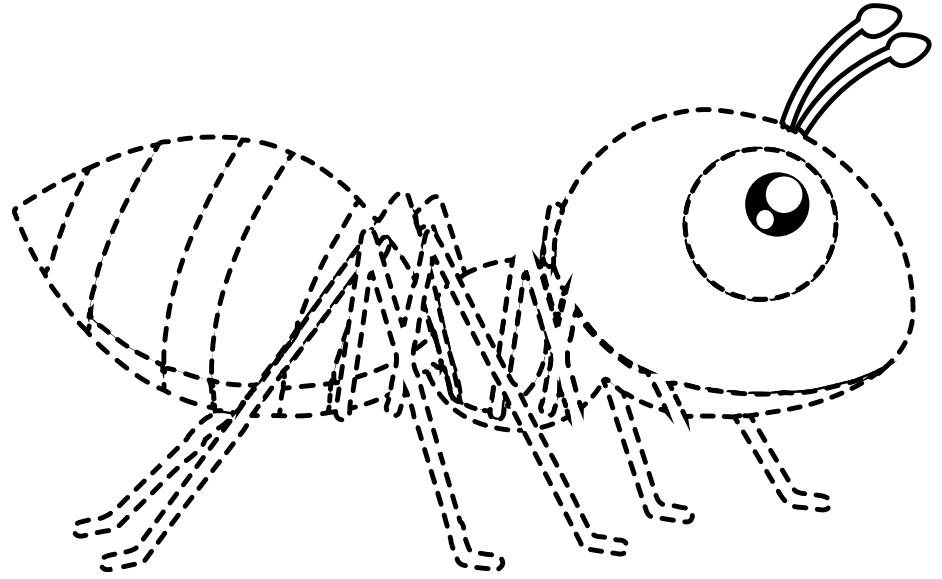
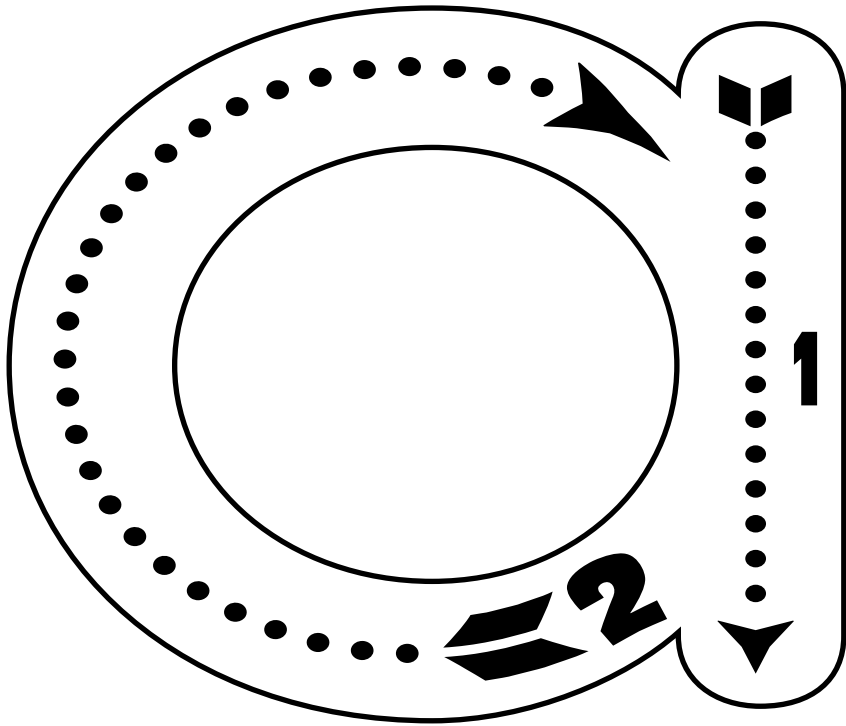

a is for ant

a a a a a a a a a
a a a a a a a a a
a a a a a a a a a
a

NAME: _____

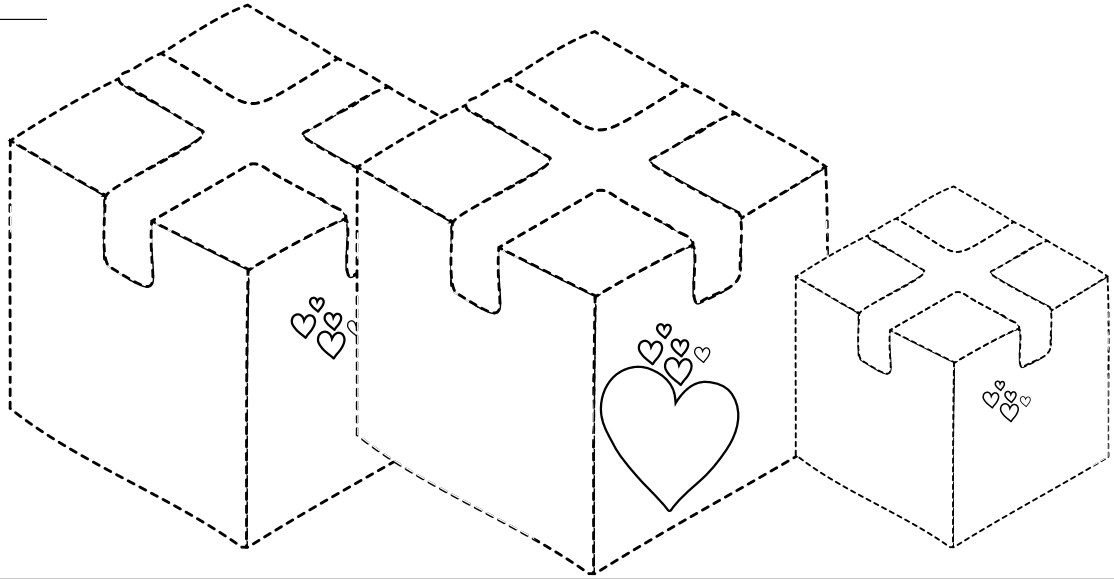
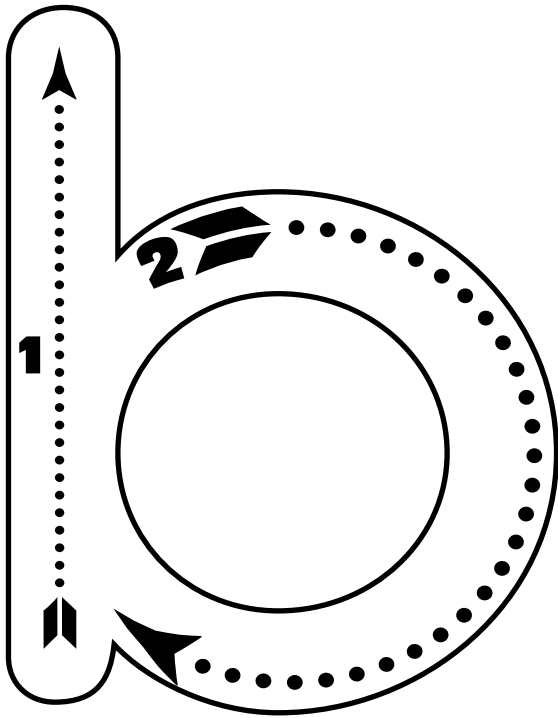

b is for box

b b b b b b b b

b b b b b b b b

b

NAME: _____

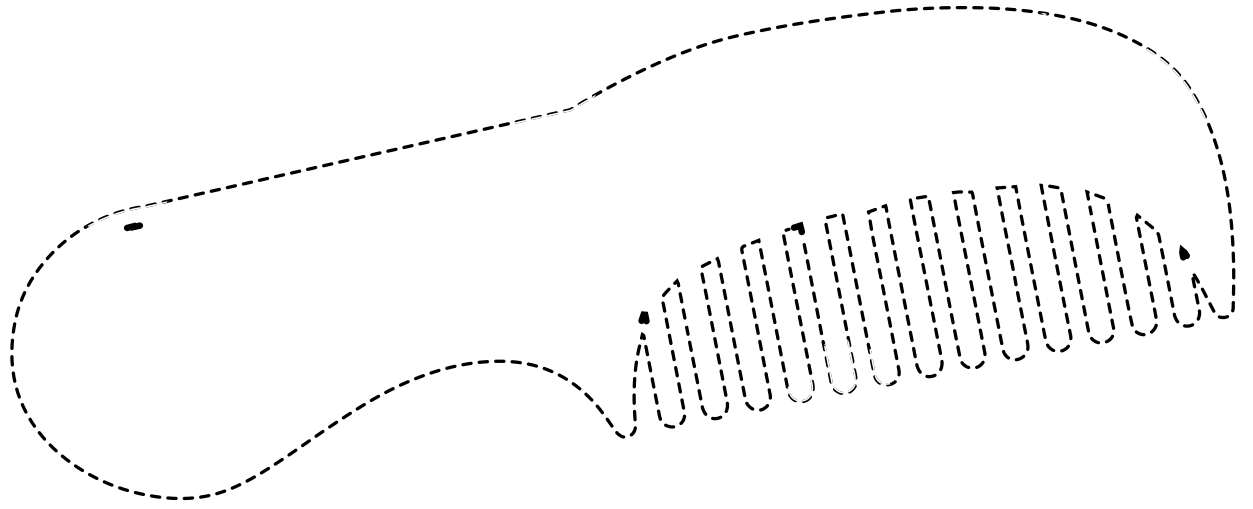
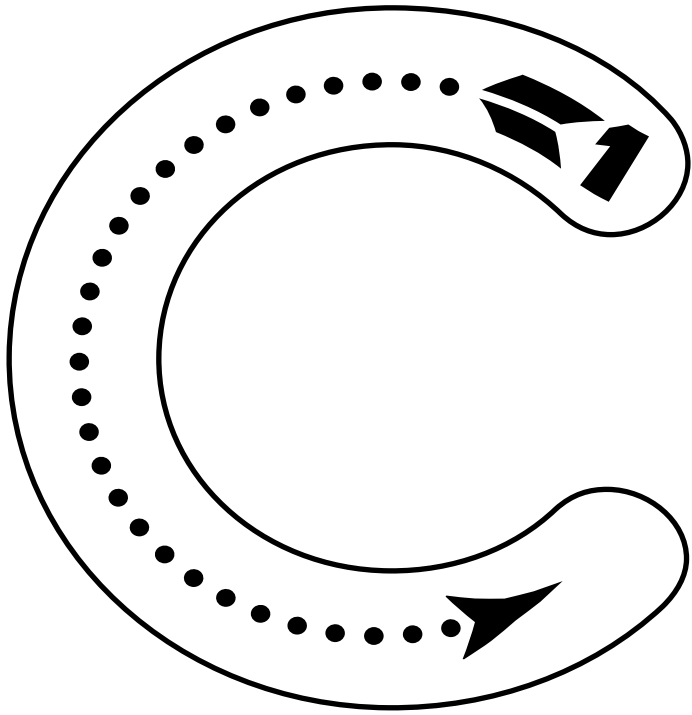

c is for comb

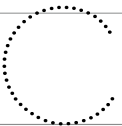
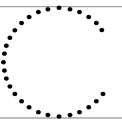
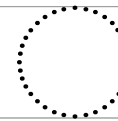
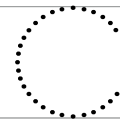
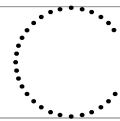
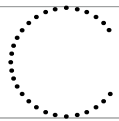
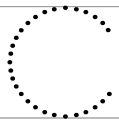
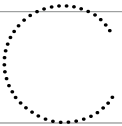
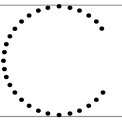
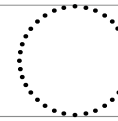
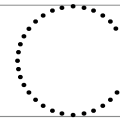
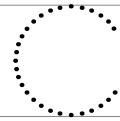
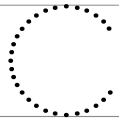
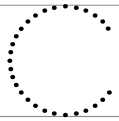
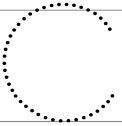

NAME: _____

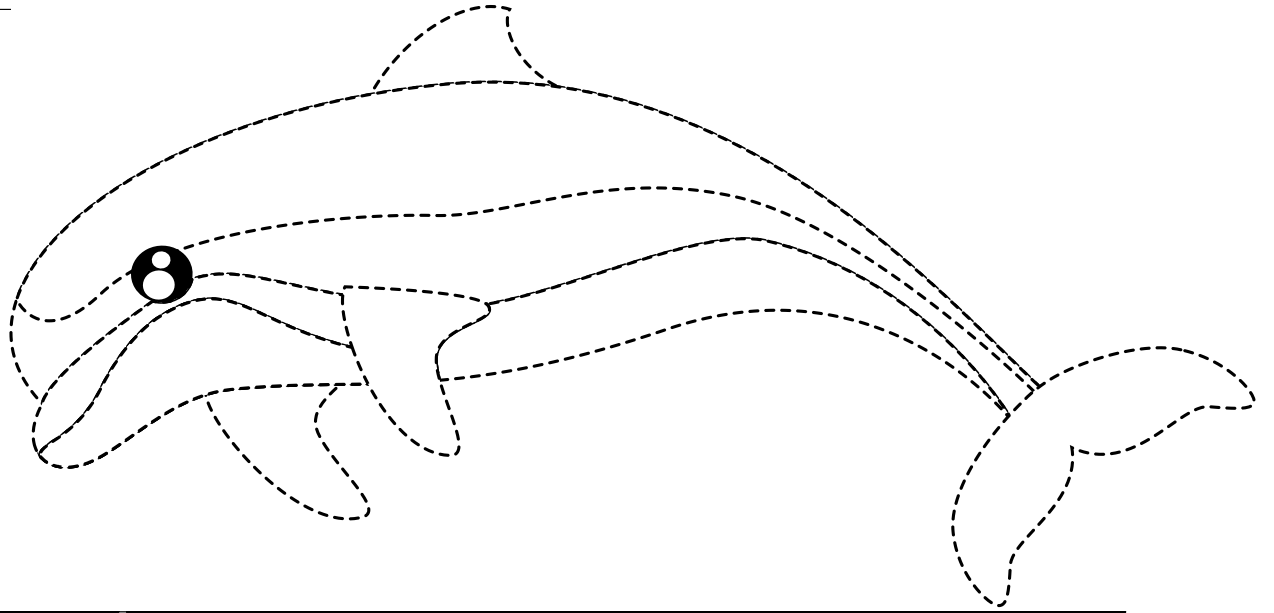
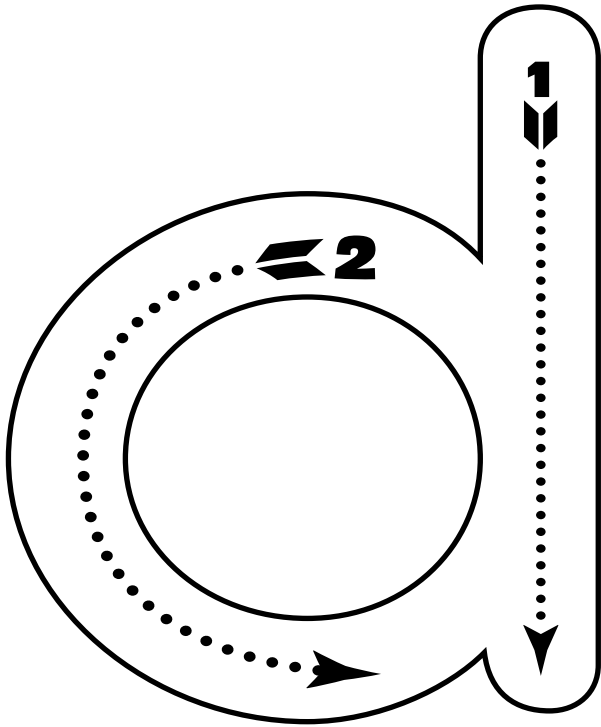

d is for dolphin

d d d d d d d d

d d d d d d d d

d

NAME: _____

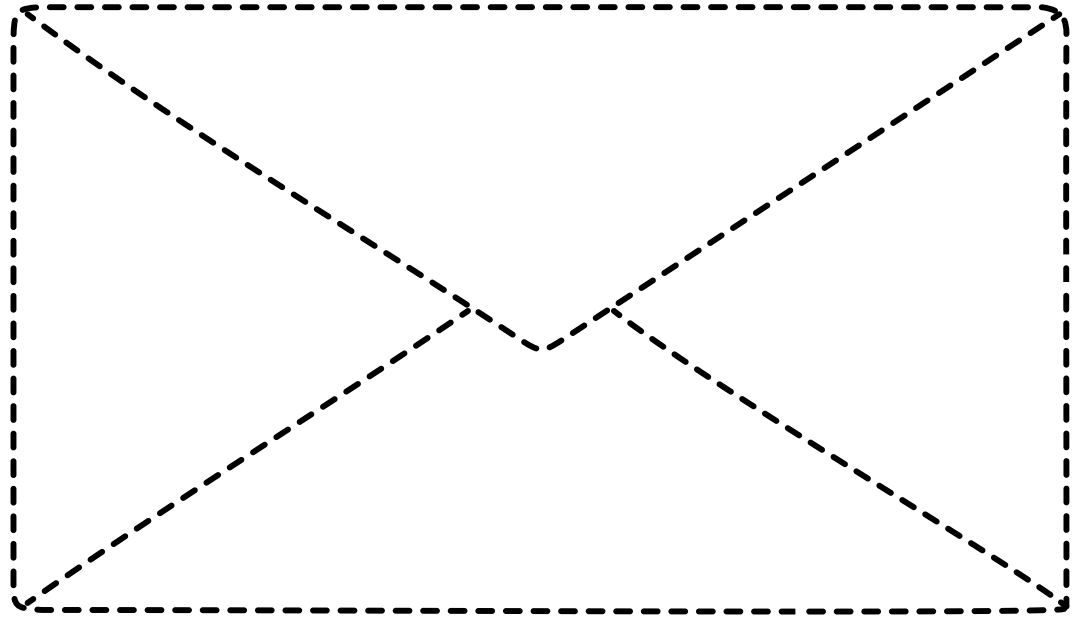
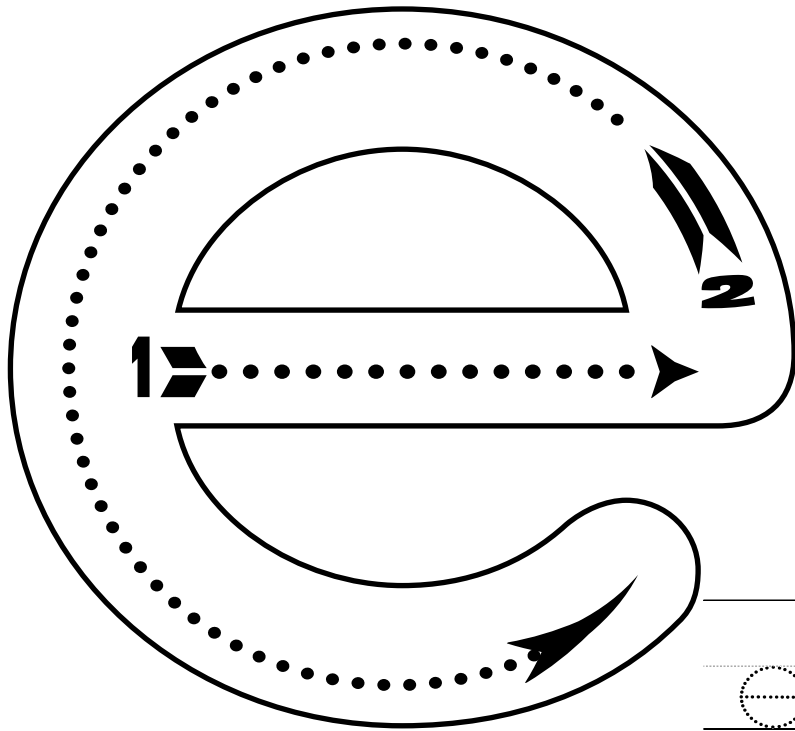

e is for envelope

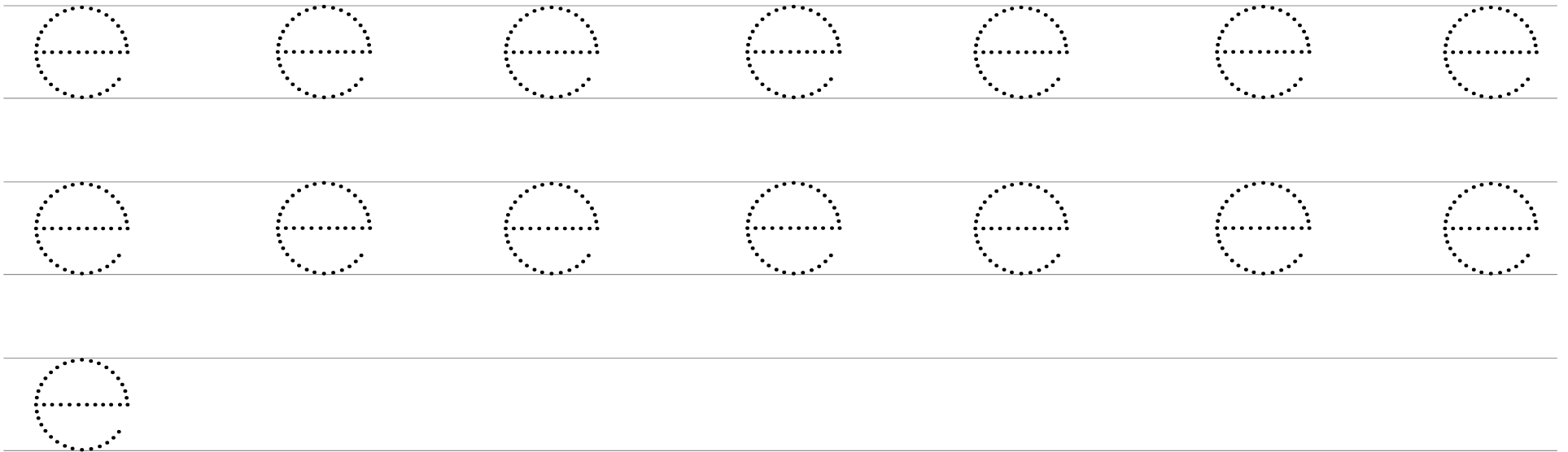

NAME: _____

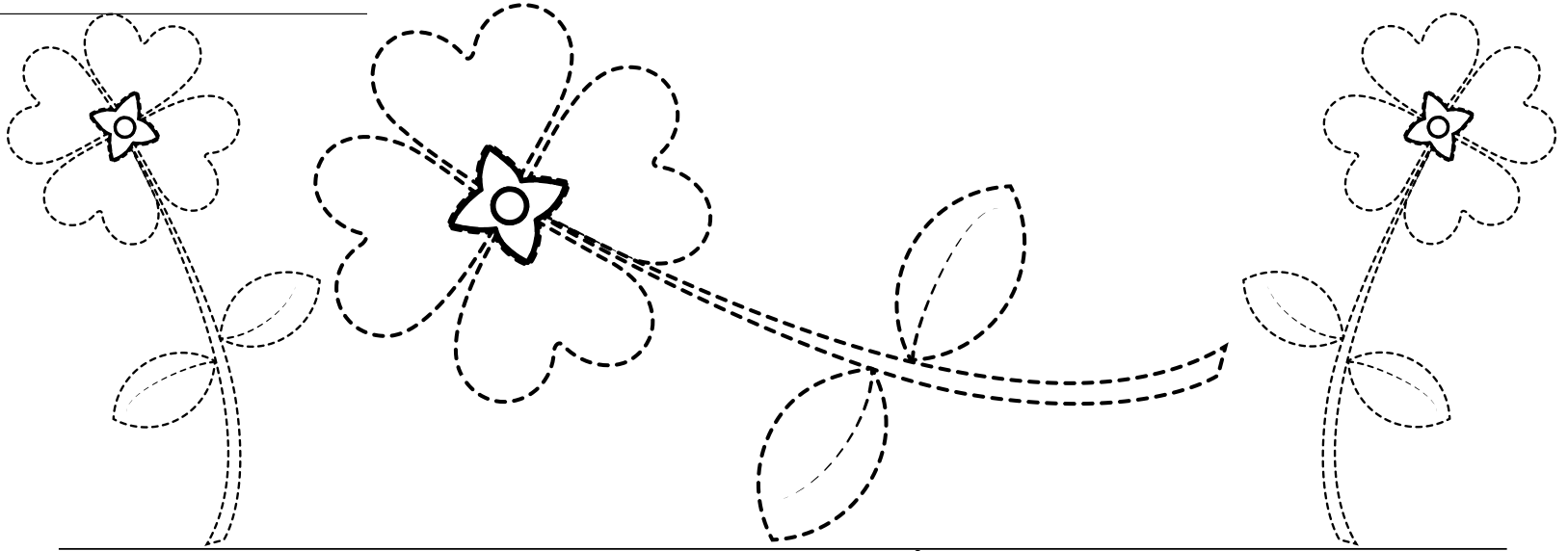
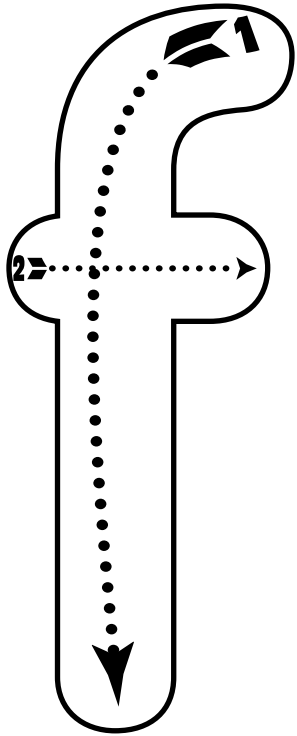

f is for flower

f f f f f f f f f f

f f f f f f f f f f

f

NAME: _____

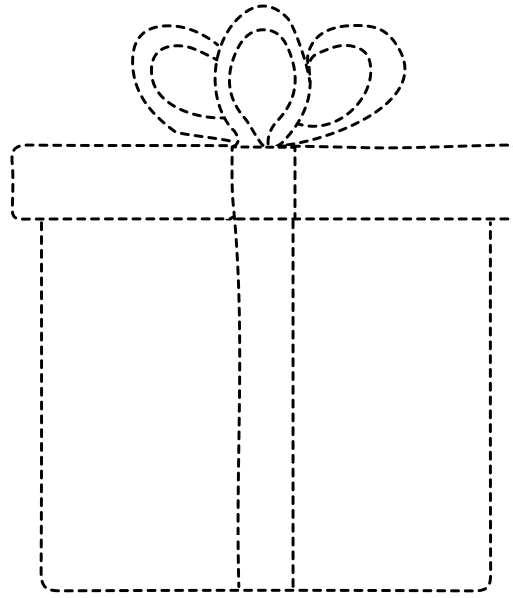
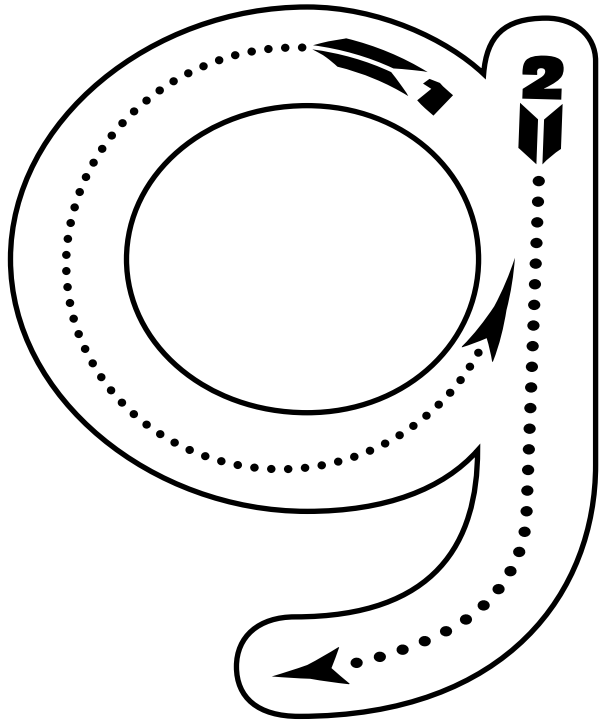

g is for gift

g g g g g g g

g g g g g g g

g

NAME: _____

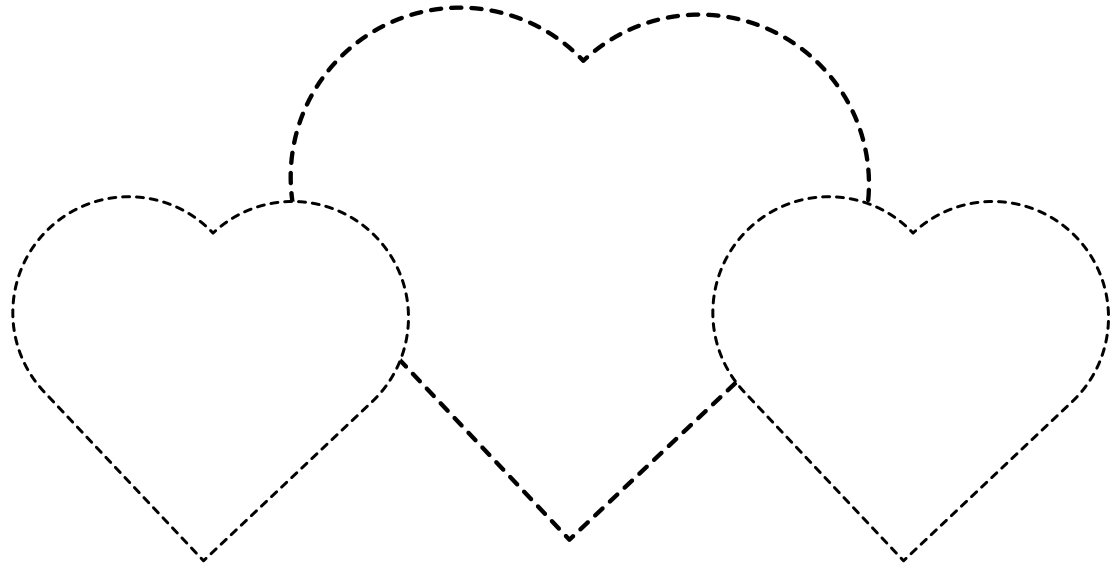
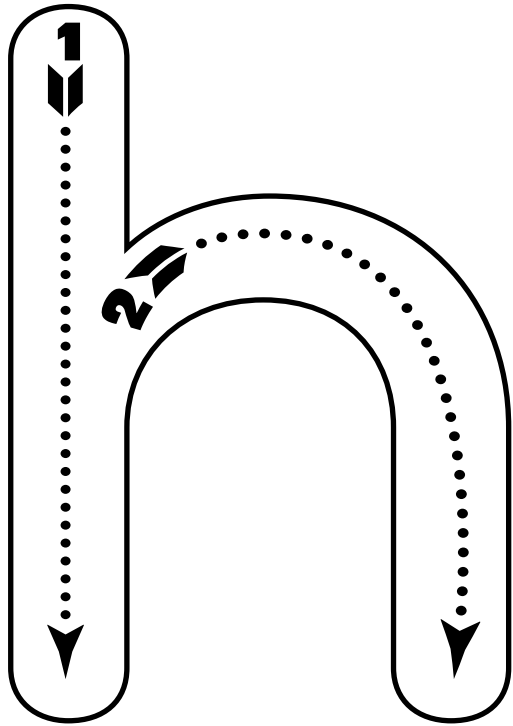

his for heart

h h h h h h h h

h h h h h h h h

h

NAME: _____

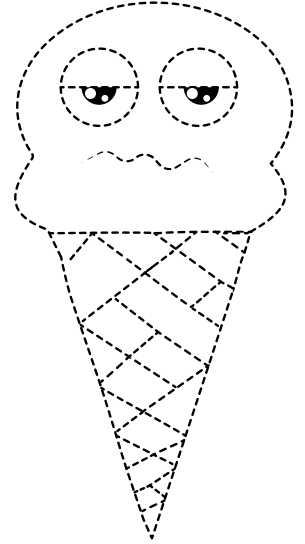
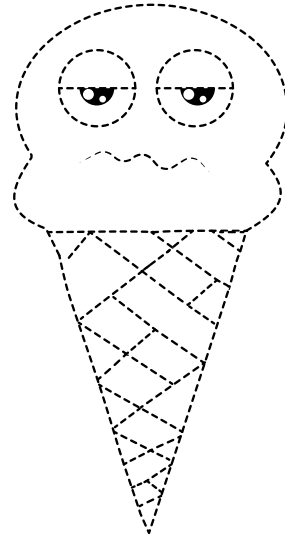
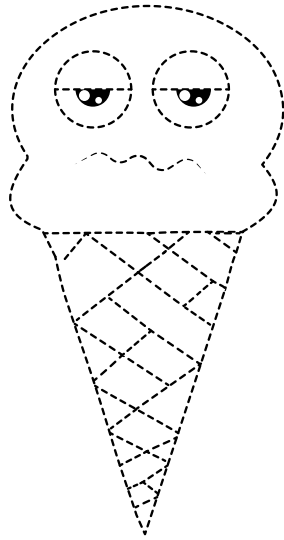
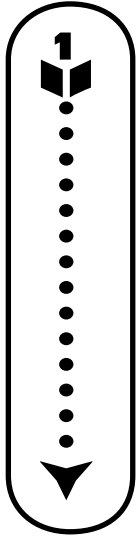
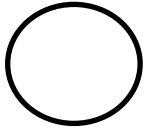

i is for ice cream

i i i i i i i

i i i i i i i

i

NAME: _____

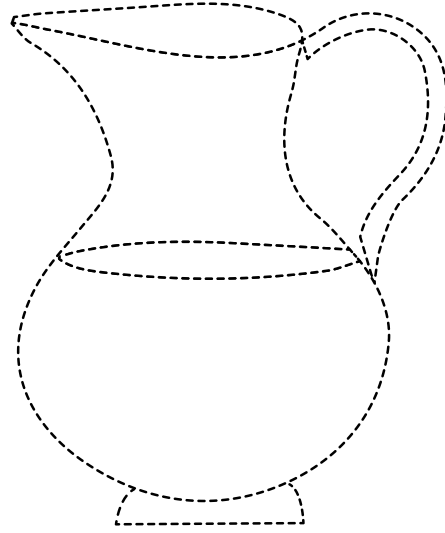
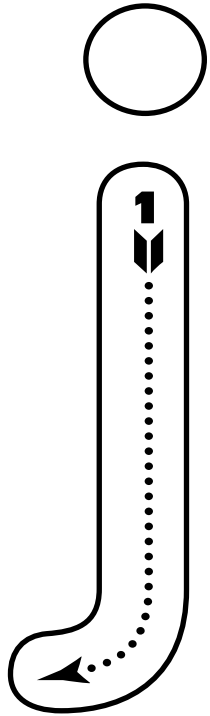

j is for juice

j j j j j j j

j j j j j j j

j

NAME: _____

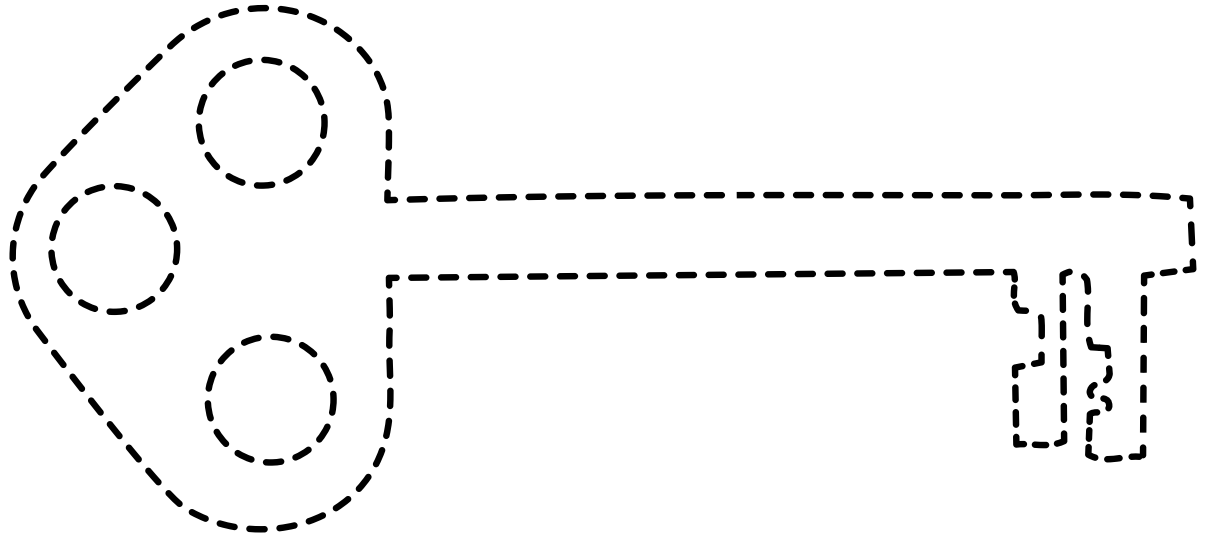
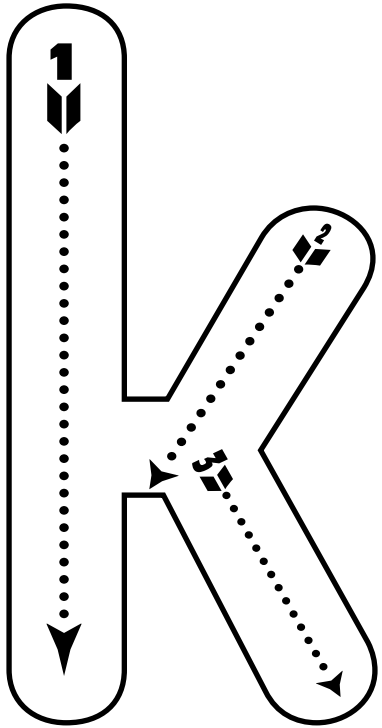

k is for key

k k k k k k k
k k k k k k k
k

NAME: _____

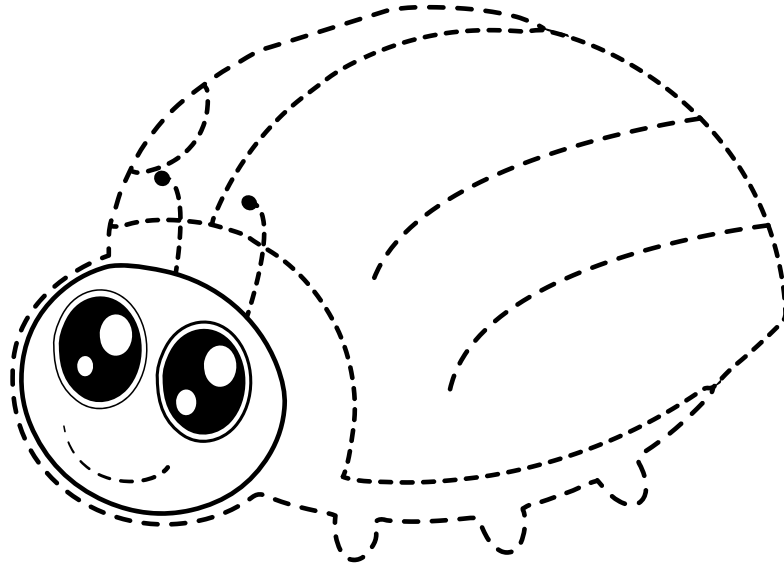
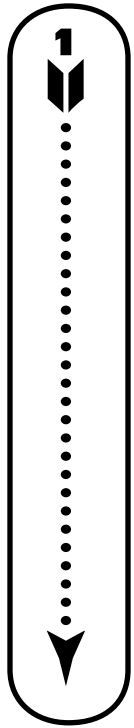

l is for ladybug

l l l l l l l l l

l l l l l l l l l

l

NAME: _____

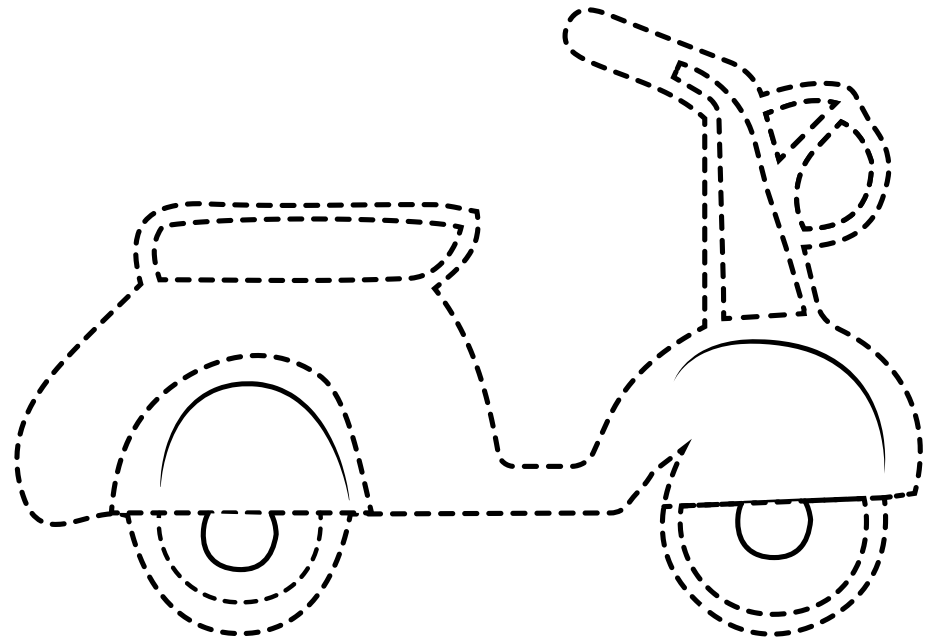
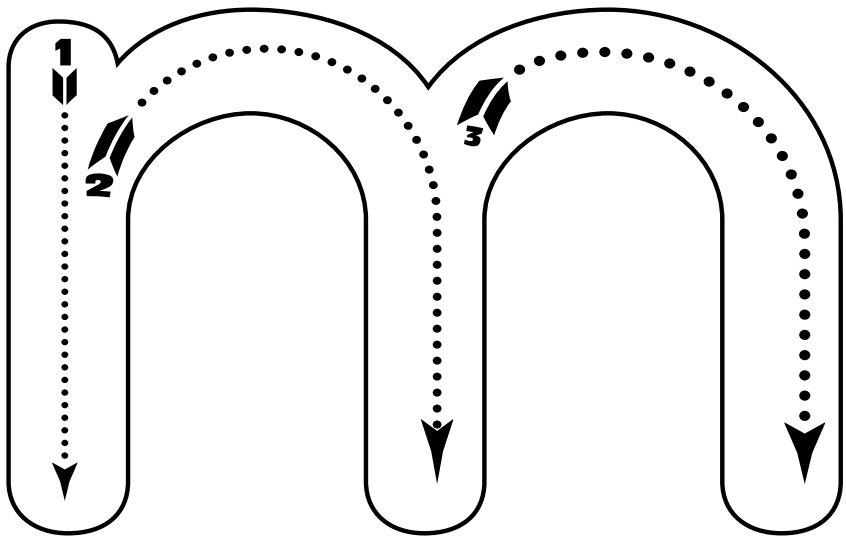

m is for motorcycle

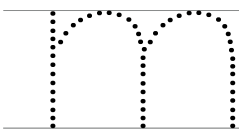
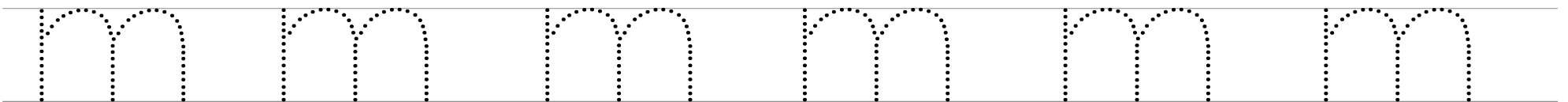
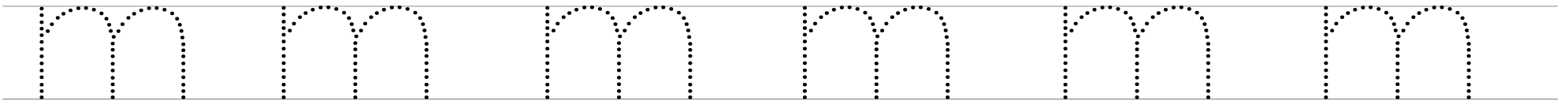

NAME: _____

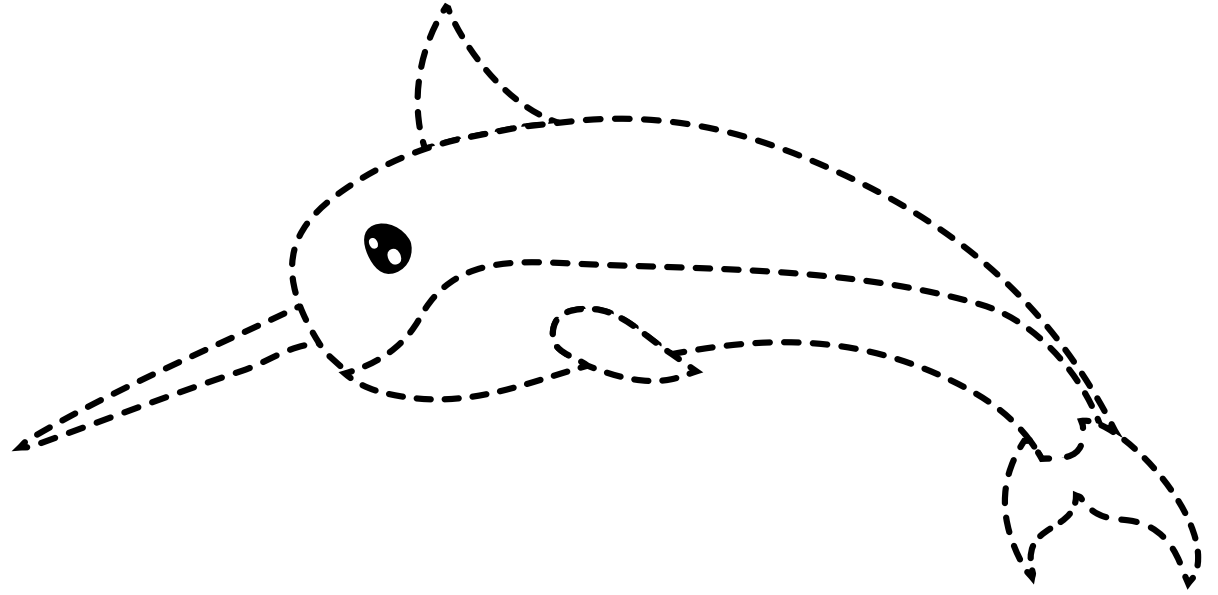
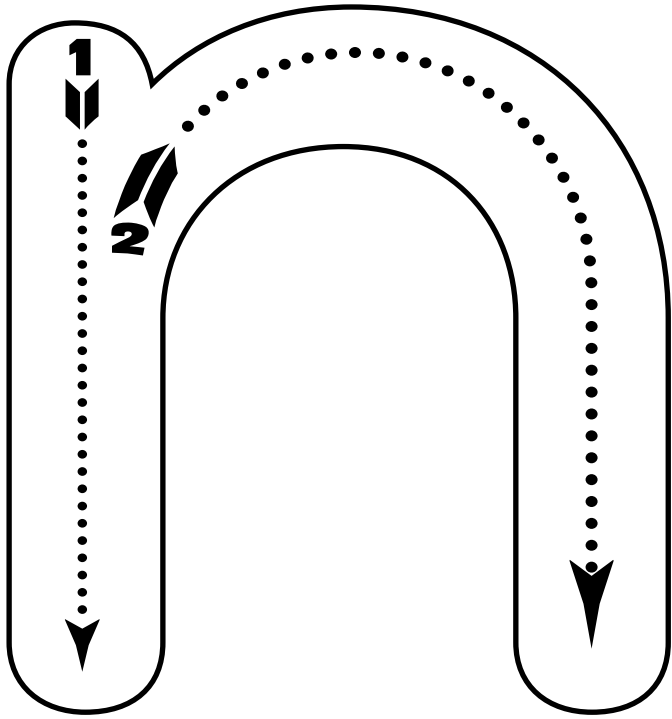

n is for narwhal

n n n n n n n n

n n n n n n n n

n

NAME: _____

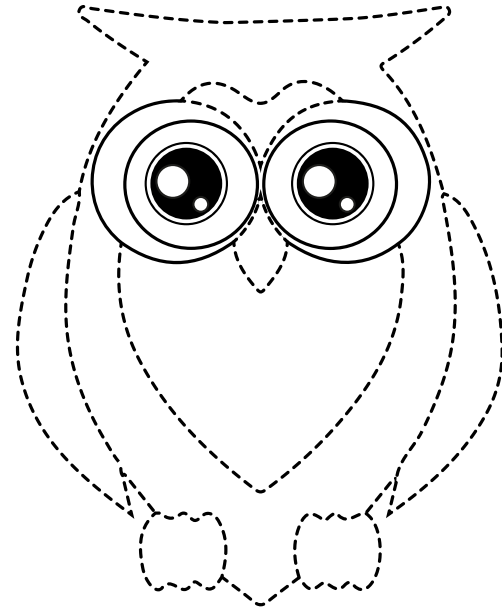
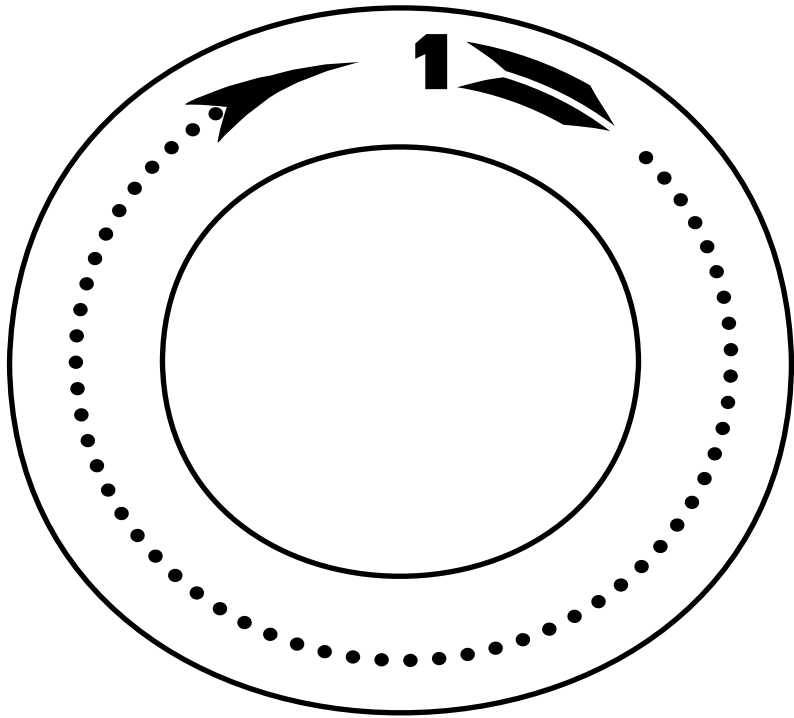

o is for owl

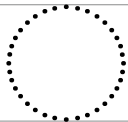
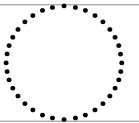
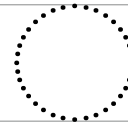
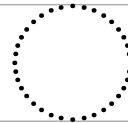
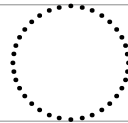
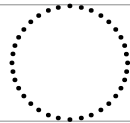
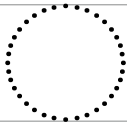
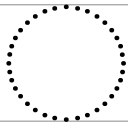
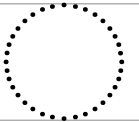
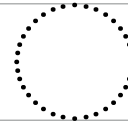
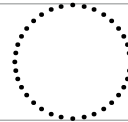
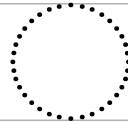
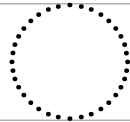
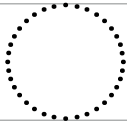
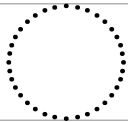

NAME: _____

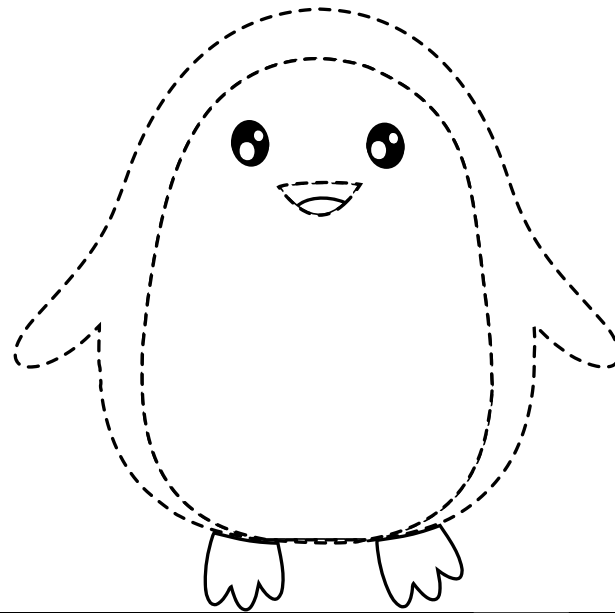
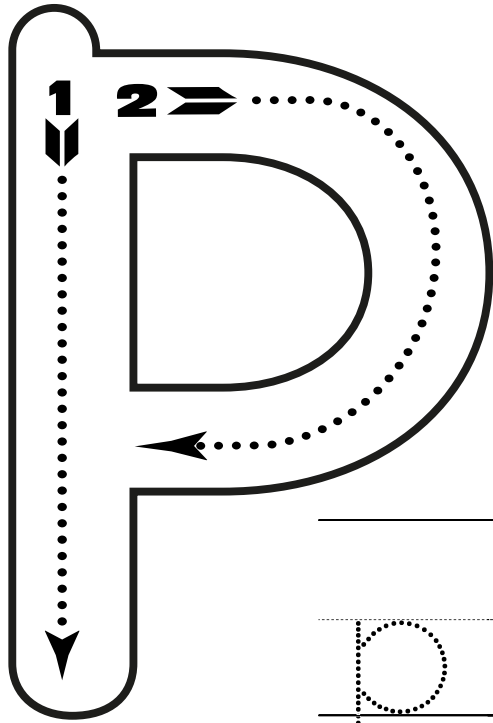

p is for penguin

p

p

p

p

p

p

p

p

p

p

p

p

p

p

p

NAME: _____

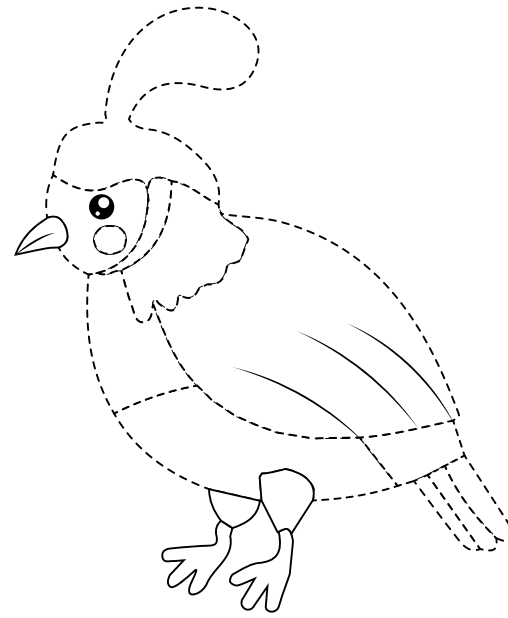
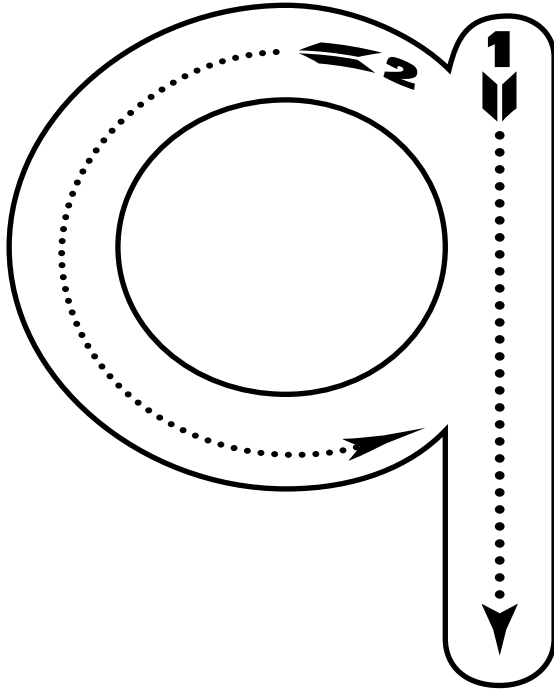

q is for quail

q q q q q q q

q q q q q q q

q

NAME: _____

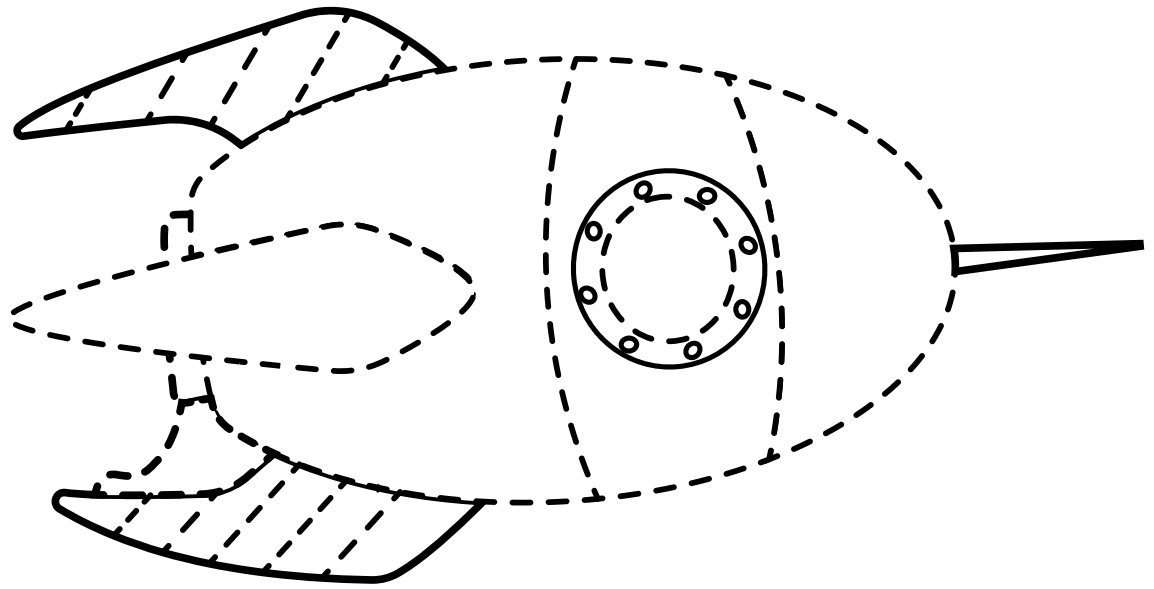
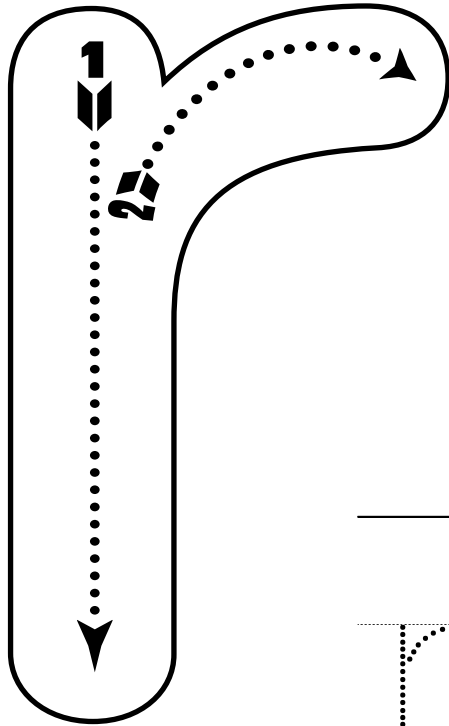

r is for rocket

r r r r r r r

r r r r r r r

r

NAME: _____

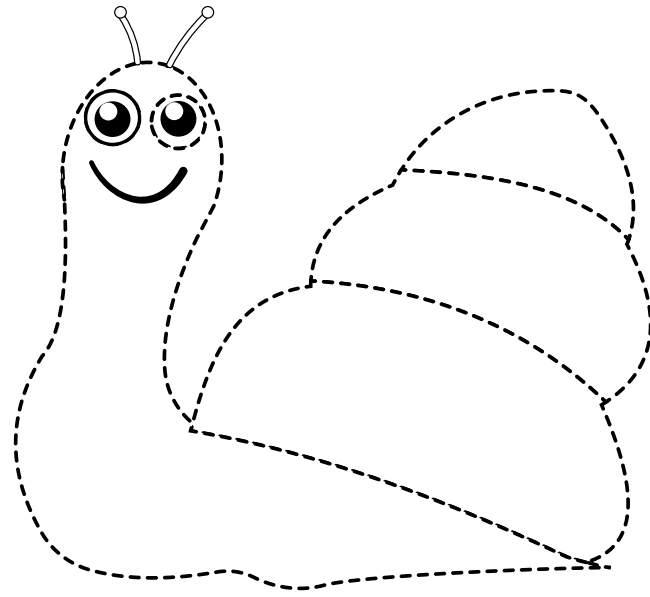
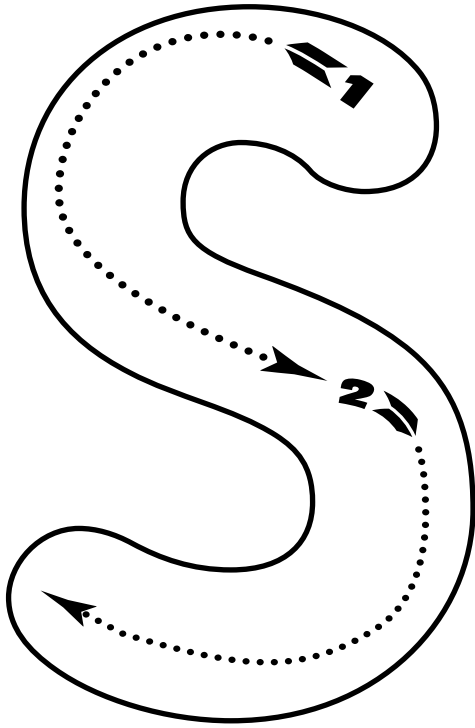

s is for snail

s s s s s s s

s s s s s s s

s

NAME: _____

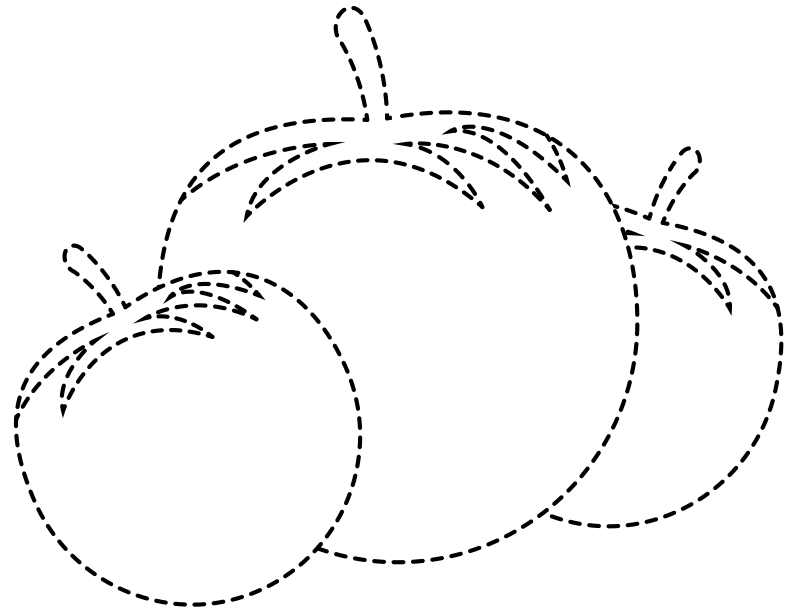
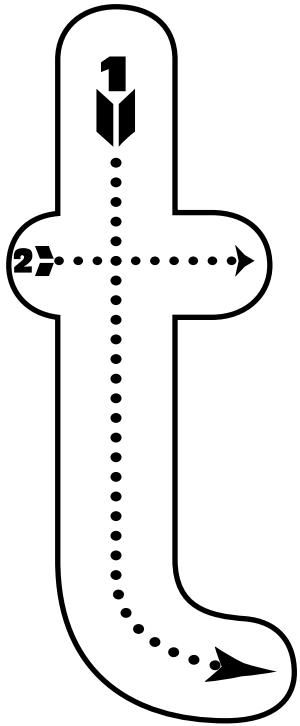

t is for tomato

t t t t t t t

t t t t t t t

t t t t t t t

NAME: _____

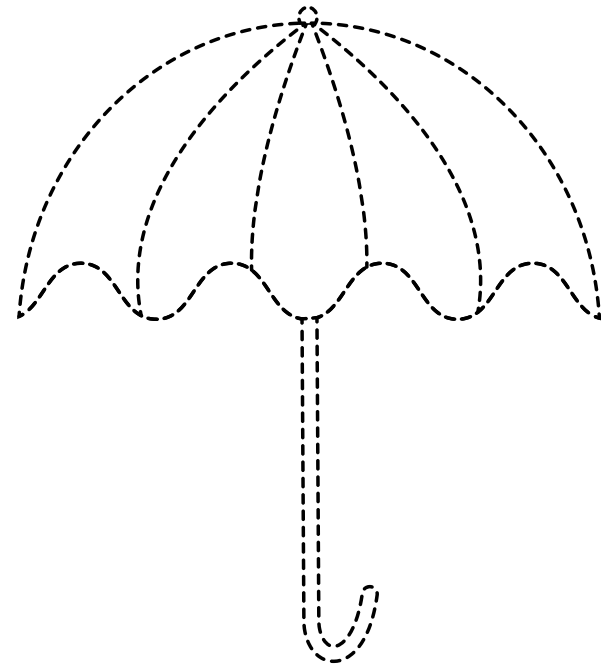
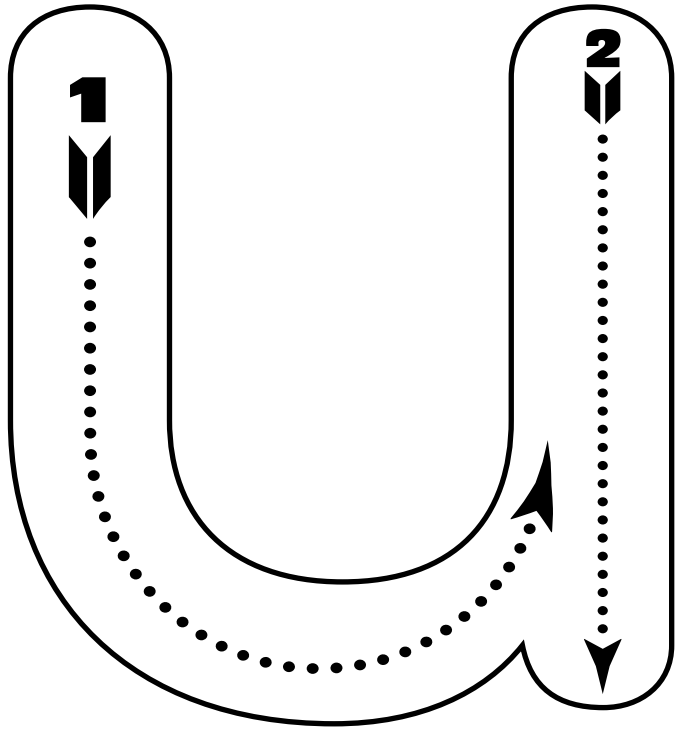

u is for umbrella

u u u u u u u
u u u u u u u
u u u u u u u

NAME: _____

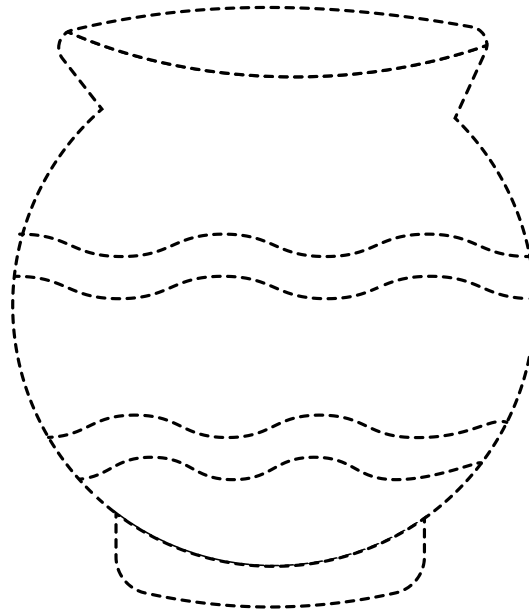
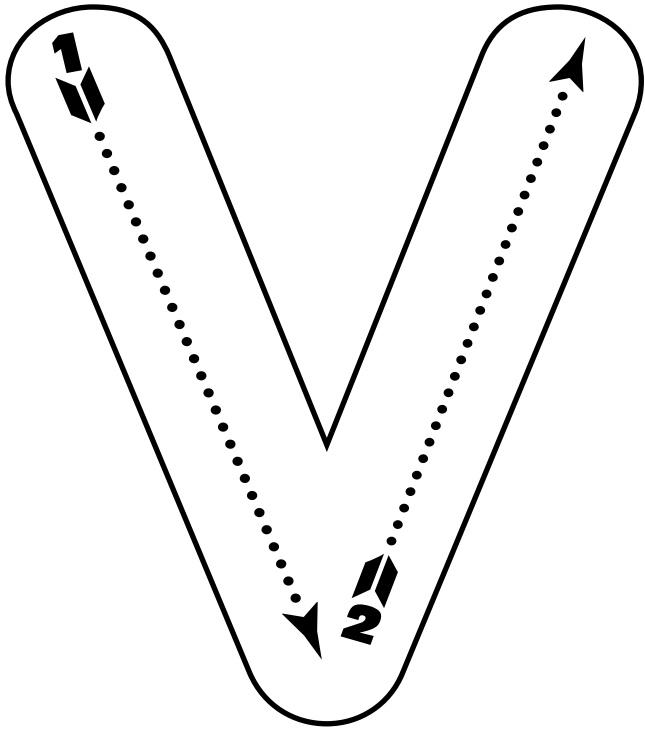

v is for vase

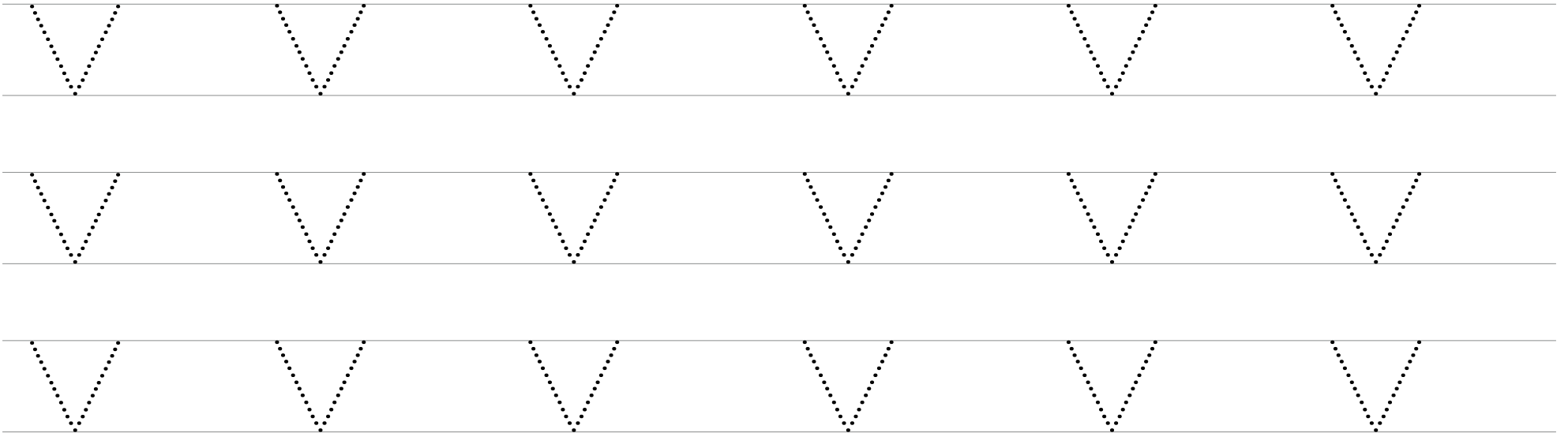

NAME: _____

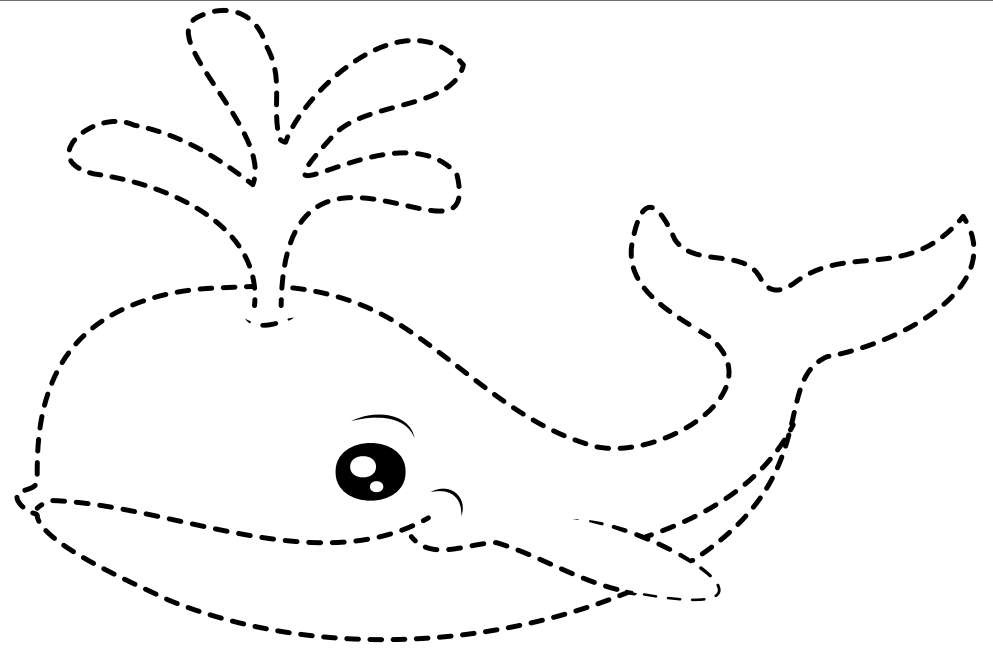
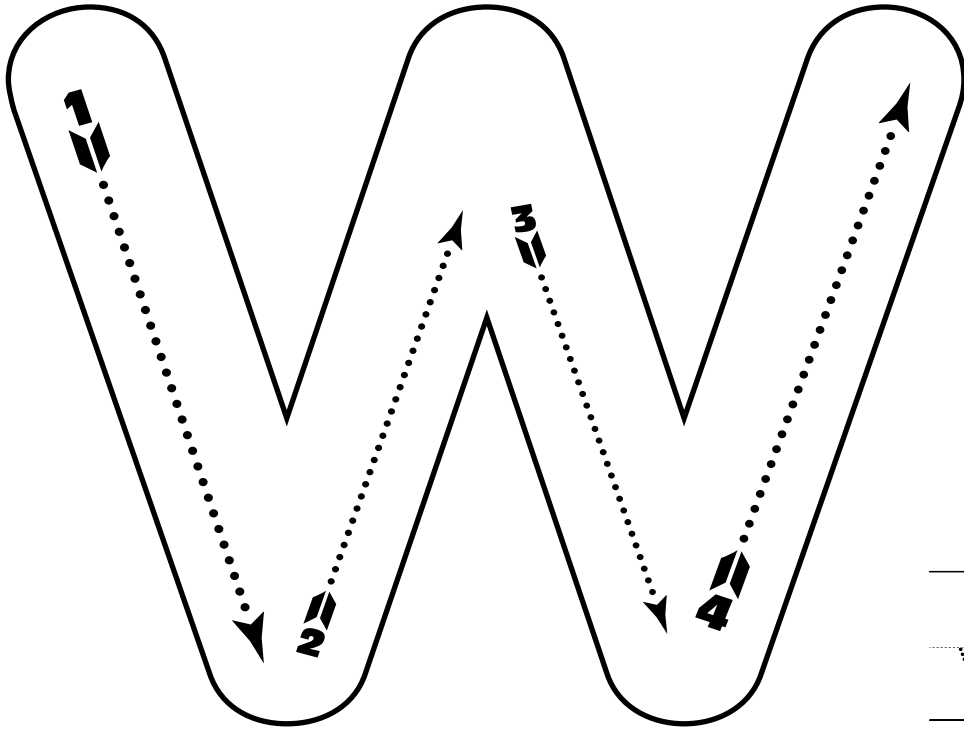

w is for whale

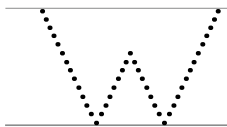
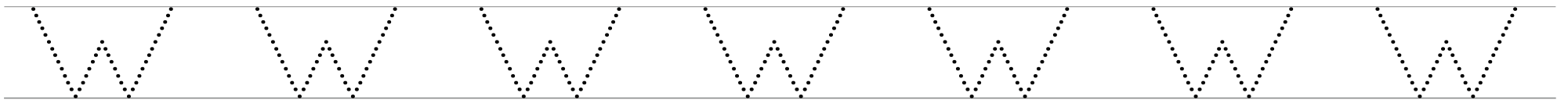
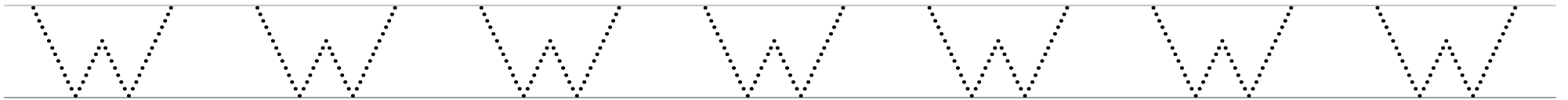

NAME: _____

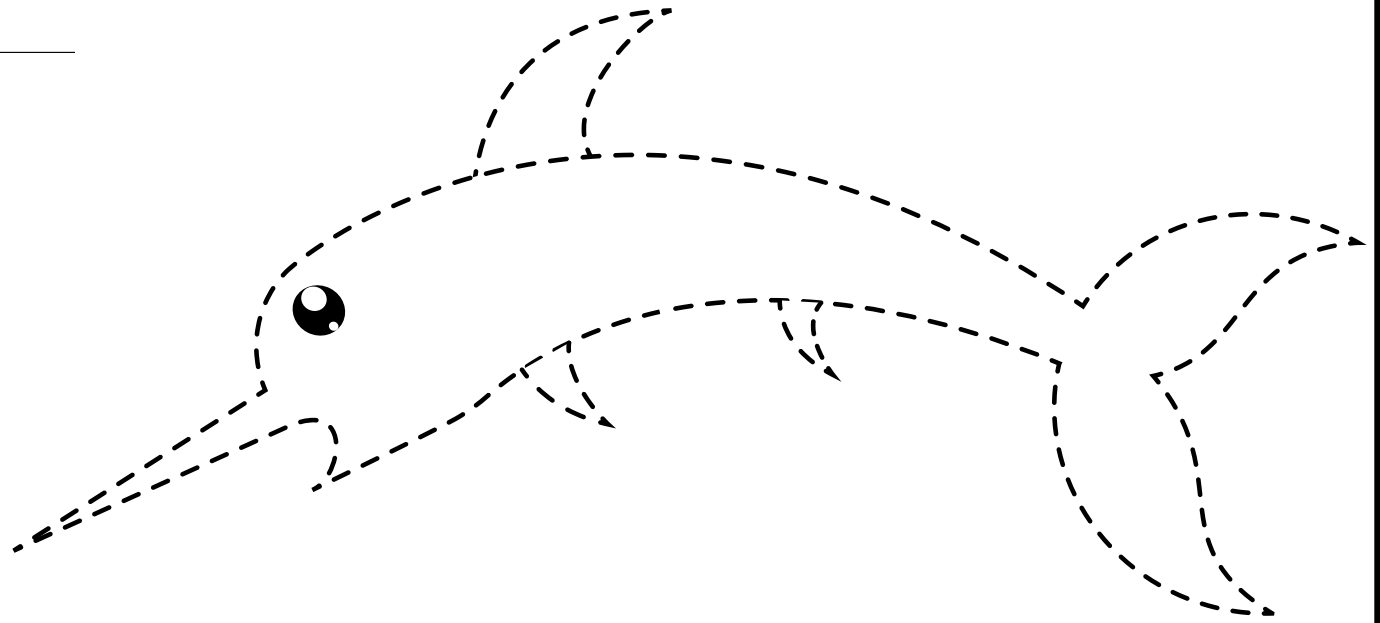
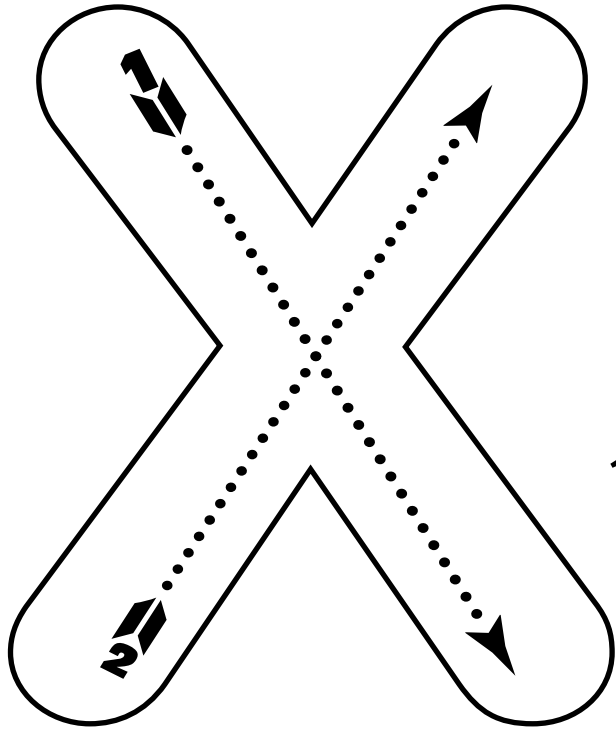

x is for xiphias

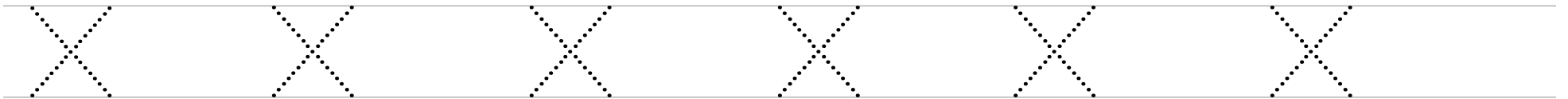
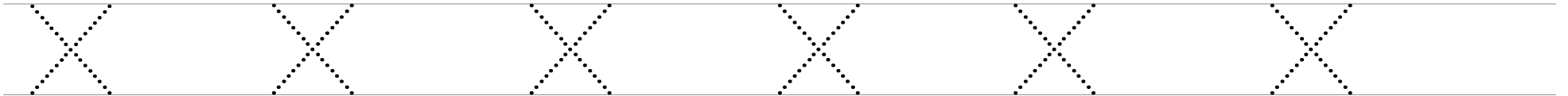

NAME: _____

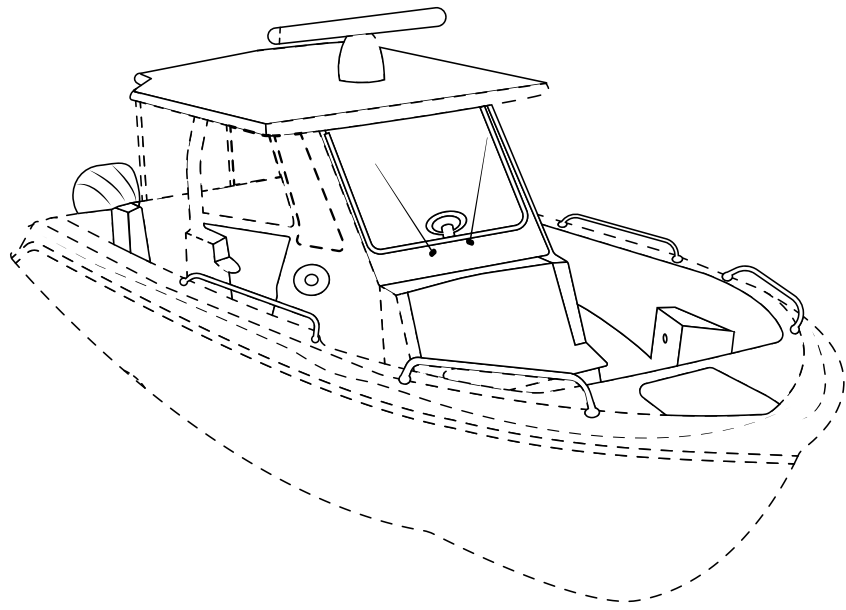
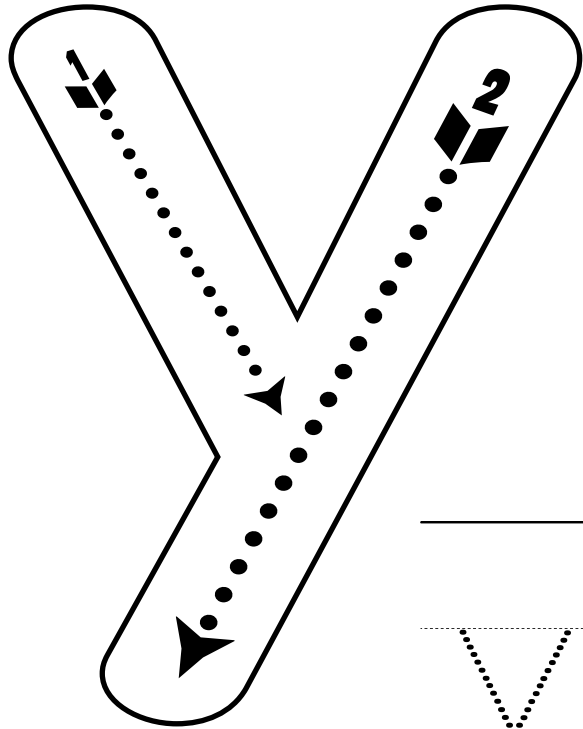

y is for yacht

y y y y y y
y y y y y y
y

NAME: _____

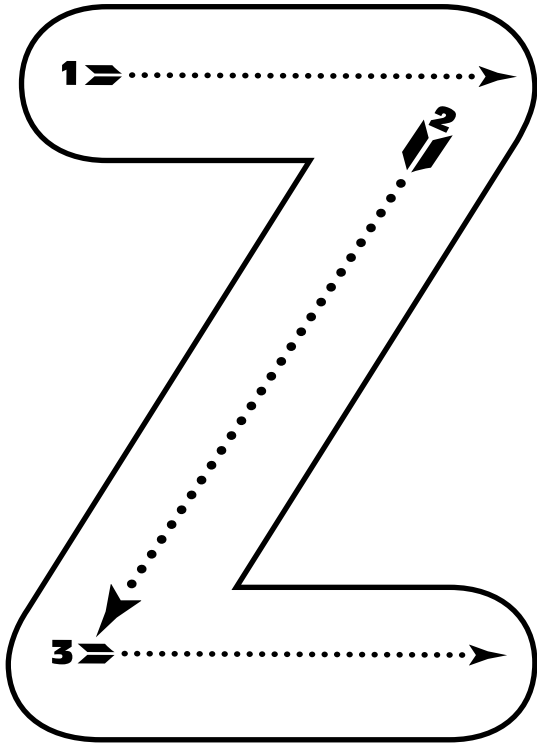

z is for zucchini

z z z z z z z
z z z z z z z
z